

decopoint®

PREMIUM PLANTERS & ARTIFICIAL PLANTS · 2025



PANDORA
silver leaf

PREMIUM
PLANTERS

2025



With our modern high rack warehouse and our motivated team we strive for the fastest delivery every day.

Mit unserem modernen Hochregallager und unserem motivierten Team bemühen wir uns täglich um schnellste Lieferung.



Alphabetical index

Accessories / Zubehör.....198	Corum.....178	Modulo.....68	Stripe.....104
Atlantis.....170	Croc.....162	Nomad Lion.....50	Styrofoam Discs /.....
Babylon 3D.....10	Curved River.....108	Organic 3D.....14	Styroporscheiben.....98
Banana.....88	Division Lite.....92	Pandora Gold Leaf.....134	Talon.....144
Big Bag 3D.....12	Fertilisier / Dünger HM 10...200	Pandora Oxidized.....138	Vases 3D.....18
Blooming Namaste.....56	Flora.....42	Pandora Silver Leaf.....136	Welcome.....8
Cigar.....140	Grace.....128	Petal.....40	Woody.....80
Cigar Oxidized.....142	Graphit.....48	Polystone.....20	
Clay / Ton.....199	Gritto.....44	Pottery.....46	
Cliff.....176	Inliner / Pflanzeinsätze.....196	Premium.....184	
Cloud.....132	Lava.....72	River.....114	
Cobalt Jungle.....52	Leaf Shine / Blattglanz.....201	Roccastone.....60	
Coconut.....72	Lemon Fusion.....58	Rocks / Dekosteine.....199	
Conical.....180	Linea.....38	Rocky.....164	
Coral.....166	Loft.....120	Royal.....148	
Cora.....66	Lush Botanic.....54	Service Car.....202	
Corten Steel.....130	Magnifico.....174	Stage.....182	



Important Notice / Wichtiger Hinweis

PRICES: All prices shown are recommended retail prices excluding VAT (RRP net excluding VAT)

OUTDOOR USE OF WATERPROOF PLANTERS: Most of our planters are waterproof as a standard to use them indoors. For outdoor use make sure to drill a hole for drainage.

Subject to change, errors and misprints excepted. Please always check the current item price in the online shop!

PREISE: Alle Preise sind unverbindliche Preise in Euro, zzgl. gesetzlicher Mehrwertsteuer (UVP netto).

AUSSENEINSATZ WASSERDICHTER GEFÄSSE: Die meisten unserer Pflanzgefäße sind standardmäßig wasserdicht für die Verwendung im Innenbereich. Für die Verwendung im Außenbereich und zum Wasserablauf ist daher ein Drainage-Loch zu bohren.

Änderung, Irrtum und Druckfehler vorbehalten. Den aktuellen Artikel-Preis bitte immer im Online-Shop überprüfen!



Caption / Legende

-  Outdoor use possible
Außeneinsatz möglich
-  Lightweight
besonders leicht
-  UV-resistant
UV-stabil
-  Items per packaging unit
Artikel je Verpackungseinheit
-  Semi-Outdoor
Außeneinsatz bedingt möglich
-  Waterproof
Wasserdicht
-  Handmade
Handgemacht
-  Items per pallet
Artikel pro Palette
-  indoor use only
Nur für Innenräume
-  Frost resistant
Frostfest
-  Number of leafes
Anzahl der Blätter



Welcoming culture.

Willkommenskultur.

The WELCOME planter is particularly hospitable. The word „Welcome“ is embossed on the body of the Polystone planter in 23 languages: German, English, Dutch, French, Greek, Italian, Portuguese, Russian, Spanish, Chinese (Mandarin), Swedish, Norwegian, Danish, Finnish, Slovak, Czech, Polish, Croatian, Slovenian, Tagalog, Japanese, Arabic, Turkish.



Passgenauer PFLANZEINSATZ

INLINER

B	20021	LECHUZA Liner	26,50 net.
---	-------	---------------	------------



WELCOME FLOOR PLANTERS / BODENVASE

Ø	Ø	□	□	kg	natural	Sales price excl. VAT	INLINER
						UVP zzgl. MwSt.	
39	22	90	85	10	A 23020	315,-	17895
52	30	120	115	22,3	B 23019	585,-	20021



WELCOME IN 2025



WELCOME #23019



SUKKULENTE
AUF STAMM
#23582

BABYLON 3D

B

PLEASE ONLY PLANT WITH INSERT
BITTE NUR MIT EINSATZ BEPFLANZEN

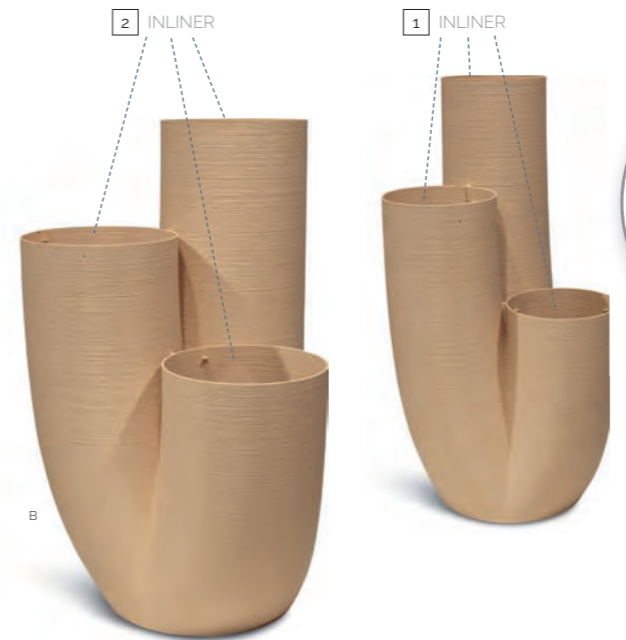

MATCHING INSERTS NOT INCLUDED!
PASSENDE EINSÄTZE NICHT INKLUSIVE!

INLINER				
1	22985	LECHUZA Liner	25,10 net.	
2	20021	LECHUZA Liner	26,50 net.	



SUSTAINABLE PRODUCT!
Made with recycled material,
model wood made within 40% wood fibers.

NACHHALTIGES PRODUKT!
Aus recyceltem Rohstoff,
teilweise mit 40% Holzfasern.



BABYLON 3D PLANTERS / PFLANZGEFÄSSE

Ø	Ø	□	□	kg	wood	midnight black	moonlight grey	stone grey	sales price excl. VAT UVP zzgl. MwSt.	SPECIAL OFFER %
48	22	90	26	4,7	A 28665	D 28664	G 28662	J 28663	449,-	20%
64	30	110	32	8,0	B 28661	E 28660	H 28658	K 28659	629,-	20%





SUSTAINABLE PRODUCT!
Made with recycled material,
model wood made within 40% wood fibers.

NACHHALTIGES PRODUKT!
Aus recyceltem Rohstoff, teilweise
mit 40% Holzfasern.



PLEASE ONLY PLANT WITH INSERT
BITTE NUR MIT EINSATZ BEPFLANZEN



ONLINE
DEAL



BIG BAG FLOOR PLANTERS / BODENGEFÄSSE

□	∅	□	□	kg	wood	midnight black	moonlight grey	stone grey	sales price excl. VAT UVP zzgl. MwSt.	SPECIAL OFFER %	INLINER
42x42	35	31	30.5	2.6	A 28657	D 28656	G 28654	J 28655	185,-	0%	18612
42x42	35	46	45	4.0	B 28653	E 28652	H 28650	K 28651	298,-	0%	18604
55x55	45	58	57	6.2	C 28649	F 28648	I 28646	L 28647	419,-	0%	18607

Big Bag 3D

GELDBAUM
CRASSULA OVATA
#20292

ALOCASIA CALIDORA -
ELEFANTENOHHR
#23578





ALOCASIA - ELEFANTENOHR #23839

ORGANIC 3D



SUSTAINABLE PRODUCT!
Made with recycled material,
model wood made within 40% wood fibers.

NACHHALTIGES PRODUKT!
Aus recyceltem Rohstoff,
teilweise mit 40% Holzfasern.



MATCHING INSERTS NOT INCLUDED!
PASSENDE EINSÄTZE NICHT INKLUSIVE!

INLINER			
1	22985	LECHUZA Liner	25,10 net.
2	20021	LECHUZA Liner	26,50 net.



PLEASE ONLY PLANT WITH INSERT
BITTE NUR MIT EINSATZ BEPFLANZEN



ORGANIC 3D FLOOR VASE / BODENVASEN

Ø	Ø	□	□	kg	wood	midnight black	moonlight grey	stone grey	sales price excl. VAT UVP zzgl. MwSt.	SPECIAL OFFER %
27	22	35	26	1.3	A 28669	D 28668	G 28666	J 28667	125,-	%
35	30	75	32	3.4	B 28681	E 28680	H 28678	K 28679	235,-	%
35	30	96.5	32	4.4	C 28685	F 28684	I 28682	L 28683	298,-	%



PLEASE ONLY PLANT WITH INSERT
BITTE NUR MIT EINSATZ BEPFLANZEN

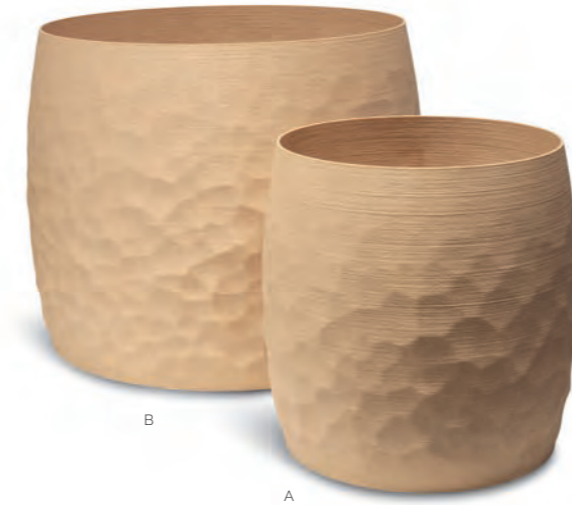

SUSTAINABLE PRODUCT!
Made with recycled material,
model wood made within 40% wood fibers.

NACHHALTIGES PRODUKT!
Aus recyceltem Rohstoff,
teilweise mit 40% Holzfasern.



ORGANIC 3D FLOOR PLANTERS / BODENGEFÄSSE

Ø	Ø	□	□	kg	wood	midnight black	moonlight grey	stone grey	sales price excl. VAT	INLINER
									UVP zzgl. MwSt.	
42.5	40	45	44	2.8	A 28673	D 28672	G 28670	J 28671	239,-	18604
69	63.5	57	56	6.6	B 28677	E 28676	H 28674	K 28675	559,-	18609



SUSTAINABLE PRODUCT
Made with recycled material.

3D
printed in
germany



Glass Vase incl.



CURVE



BOWL



DROP



NEW!
NEU!

COLORS



lemon yellow lilac purple pink blossom ash grey white frost forest green desert sand black velvet

VASES 3D

Ø	Ø	□	▣	kg	FORM	lemon yellow	lilac purple	pink blossom	ash grey	white frost	forest green	desert sand	black velvet	Sales price excl. VAT UVP zzgl. MwSt.
21	11.5	20	17	1.0	CURVE	29181	29179	29182	29175	29178	29180	29176	29177	41.-
21	11.5	20	17	1.0	BOWL	29189	29187	29190	29183	29186	29188	29184	29185	41.-
19.5	11.5	20	17	1.0	DROP	29197	29195	29198	29191	29194	29196	29192	29193	41.-



CUBE

B



POLYSTONE PLANT CUBE / PFLANZWÜRFEL

□	▤	□	▤	kg	Sales price excl. VAT			INLINER	
					grey	creme	anthracite		UVP zzgl. MwSt.
40 x 40	34	40	38	7	A 17219	D 17218	G 18042	185,-	18612
50 x 50	44	50	48	10	B 17221	E 17220	H 18043	275,-	18613
60 x 60	54	60	59	15	C 17223	F 17222	I 18044	398,-	18608





DIVIDER

Defining areas. Bereiche definieren.



POLYSTONE DIVIDER / RAUMTEILER

				kg	Sales price excl VAT UVP zzgl. MwSt.		
100 x 35	94 x 30	80	78	25.5	creme	grey	anthracite
A	B	C	D	21.0	17246	17247	18056
D	E	F			28686	28688	28687
					529,-	419,-	









For every purpose.

Für jede Anwendung.



POLYSTONE PLANTER BOX / PFLANZKASTEN

				kg	Sales price excl. VAT			
					creme	grey	anthracite	UVP zzgl. MwSt.
65 x 18	61 x 14	18	16	3,5	A 18596	B 18597	C 18598	105,-
100 x 35	92 x 28	30	28	12,5	D 17248	E 17249	F 18057	239,-





TOWER

H



Columns.
Säulen.



POLYSTONE PLANT COLUMN / PFLANZSÄULE

□	■	□	■	kg	Sales price excl. VAT			INLINER	
					creme	grey	anthracite		UVP zzgl. MwSt.
35 x 35	26	70	63	11.5	G 23013	J 23014	M 23015	249.-	18611
35 x 35	26	100	92	11.9	H 23042	K 23043	N 23044	319.-	18611
40 x 40	26	120	113	20	I 23045	L 23046	O 23047	398.-	18612



GLOBE



Allrounder. Runde Sache.



POLYSTONE GLOBE

Ø	Ø	□	▣	kg	creme	grey	anthracite	Sales price excl VAT UVP zzgl. MwSt.	INLINER
40	25	28,5	27	3,5	A 28406	D 28407	G 28405	139,-	17897
60	36	43	38	8,75	B 21030	E 21029	H 21031	265,-	18605
80	50	57	54	15,5	C 21033	F 21032	I 21034	465,-	18609



MATCHING INSERTS NOT INCLUDED!
PASSENDE EINSÄTZE NICHT INKLUSIVE!

INLINER			
A+C	22985	LECHUZA Liner	25,10 net.
B+D	20021	LECHUZA Liner	26,50 net.



ESSENCE FLOOR PLANTERS / BODENVASE								Sales price excl. VAT UVP zzgl. MwSt.	
Ø	Ø	□	□	kg		crème	grey		
39	22	90	88	9,0	A	23007	C	23008	235,-
52	30	120	118	18,5	B	23010	D	23011	479,-

Timeless beauty.
Zeitlos schön.





Classic anthracite.

Klassisch anthrazit.



MATCHING INSERTS NOT INCLUDED!
PASSENDE EINSÄTZE NICHT INKLUSIVE!

INLINER

A	22985	LECHUZA Liner	25,10 net.
B	20021	LECHUZA Liner	26,50 net.



B



B

A



ESSENCE FLOOR VASE / BODENVASEN

Ø	Ø	□	□	kg	anthracite	sales price excl. VAT UVP zzgl. MwSt.
39	22	90	88	9,0	A 23009	235,-
52	30	120	118	18,5	B 23012	479,-



MATCHING INSERTS NOT INCLUDED!
PASSENDE EINSATZE NICHT INKLUSIVE!

INLINER
A-I 20021 LECHUZA Liner 26,50 net.



Modern classics.
Moderne Klassiker.



POLYSTONE CONICAL FLOOR VASE / BODENVASE

Ø	Ø	□	□	kg	creme	grey	anthracite	Sales price excl. VAT UVP zzgl. MwSt.
43	30	80	72	12,5	A 21018	D 21017	G 21019	269,-
46	30	95	87	15,5	B 21021	E 21020	H 21022	325,-
48	30	110	102	18	C 21024	F 21023	I 21025	395,-



Brings style to
the table.
Tischgerecht.



POLYSTONE EGO PLUS BOWL / PFLANZSCHALE

Ø	Ø	□	□	kg	creme	grey	anthracite	Sales price excl. VAT UVP zzgl. MwSt.
40	33	18	17	2,5	A 17238	E 17239	I 18052	79,-
50	42	22	21	4	B 17240	F 17241	J 18053	135,-
70	60	32	30	9	C 17242	G 17243	K 18054	259,-





EGO GIANT



F



Natural colours.
Naturtöne.



POLYSTONE EGO GIANT FLOOR PLANTER / BODENGEFÄSS



Ø	Ø	□	□	kg	Sales price excl. VAT			INLINER	
					creme	grey	anthracite		
70	60	60	58	15.5	A 17968	C 17966	E 18064	398.-	18609
80	71	70	67	19.5	B 17969	D 17967	F 18065	585.-	18610



LINEA



PLANTERS / PFLANZGEFÄSSE

Ø	Ø	□	□	kg	anthracite			grey			white			sales price excl. VAT UVP zzgl. MwSt.	INLINER
					A-1	A-2	A-3	B-1	B-2	B-3	C-1	C-2	C-3		
37	34	30	27	6.4	A-1	28585	B-1	28589	C-1	28593	49.-	18603			
44	40	36	33	9.6	A-2	28584	B-2	28588	C-2	28592	79.-	18604			
55	50	43.5	40	12.5	A-3	28583	B-3	28587	C-3	28591	99.-	18696			
3er Set				28.4	A	28582	B	28586	C	28590	205.-	BEST PRICE %	-		





PETAL



PLANTERS / PFLANZGEFÄSSE

Ø	Ø	□	▣	kg	sales price excl. VAT			INLINER				
					anthracite	white	grey		UVP zzgl. MwSt.			
37	34	30	27	6.4	A-1	28597	B-1	28638	C-1	28601	49,-	18603
44	40	36	33	9.6	A-2	28596	B-2	28637	C-2	28600	79,-	18604
55	50	43.5	40	12.5	A-3	28595	B-3	28636	C-3	28599	99,-	18696
3er Set				28.4	A	28594	B	28635	C	28598	205,-	BEST PRICE % -





FLORA



PLANTERS / PFLANZGEFÄSSE

Ø	Ø	□	□	kg	color			sales price excl VAT	INLINER
					anthracite	grey	white	UVP zzgl. MwSt.	
37	34	30	27	6.4	A-1 28618	B-1 28622	C-1 28626	49.-	18603
44	40	36	33	9.6	A-2 28617	B-2 28621	C-2 28625	79.-	18604
55	50	43.5	40	12.5	A-3 28616	B-3 28620	C-3 28624	99.-	18696
3er Set				28.4	A 28615	B 28619	C 28623	205.-	BEST-PRICE % -



GRITTO



PLANTERS / PFLANZGEFÄSSE

Ø	Ø	□	▣	kg	anthracite		grey		sales price excl. VAT	
									UVP zzgl. MwSt.	INLINER
37	34	30	27	6,4	A-1	28605	B-1	28609	49,-	18603
44	40	36	33	9,6	A-2	28604	B-2	28608	79,-	18604
55	50	43,5	40	12,5	A-3	28603	B-3	28607	99,-	18696
3er Set				28,4	A	28602	B	28606	205,-	BEST-PRICE % -



POTTERY



PLANTERS / PFLANZGEFÄSSE

Ø	Ø	□	▣	kg	anthracite		grey		sales price excl VAT	INLINER
					G-1	28630	H-1	28634		
37	34	30	27	6,4	G-1	28630	H-1	28634	49,-	18603
44	40	36	33	9,6	G-2	28629	H-2	28633	79,-	18604
55	50	43,5	40	12,5	G-3	28628	H-3	28632	99,-	18696
3er Set				28,4	G	28627	H	28631	205,-	BEST-PRICE % -



H-2

H-3

H-1



GRAPHIT



PLANTERS / PFLANZGEFÄSSE

Ø	Ø	□	▣	kg	anthracite	sales price excl VAT	
						UVP zzgl. MwSt.	INLINER
37	34	30	27	6,4	A-1 28614	49,-	18603
44	40	36	33	9,6	A-2 28613	79,-	18604
55	50	43,5	40	12,5	A-3 28612	99,-	18696
3er Set				28,4	A 28611	205,-	BEST-PRICE % -

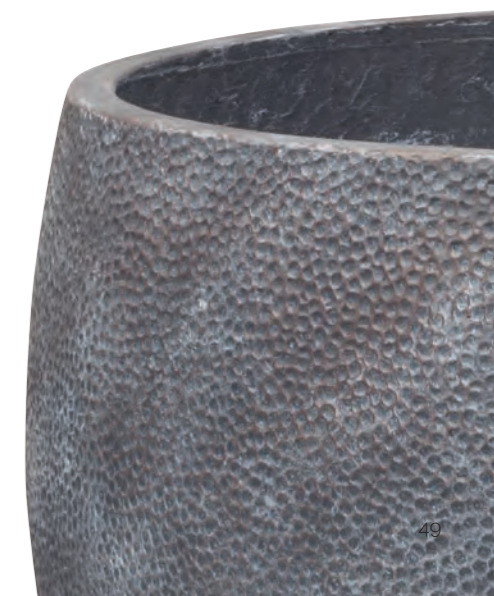



NOMAD LION



PARADIESVOGELBLUME -
STRELITZIE
#28430



NOMAD LION PLANTERS / PFLANZGEFÄSSE

Ø	Ø	□	□	kg	multicolor	sales price excl. VAT		
						UVP zzgl. MwSt.	INLINER	
30	19.7	43	42.7	2.3	D	28549	105,-	19799
47	30.7	62	61.7	5.5	E	28548	198,-	18614
2er Set NOMAD LION					D-E	28547	275,-	BEST-PRICE %

ENAMELED ALUMINIUM
EMALLIERTES ALUMINIUM



NOMAD LION TABLE TOP VASE / TISCHGEFÄSS

Ø	Ø	□	□	kg	multicolor	sales price excl. VAT		
						UVP zzgl. MwSt.	INLINER	
23	22	22	21.5	0.9	A	28553	35,-	17895
27	25.5	25.5	25	1.3	B	28552	45,-	19799
31	30	29	28.5	1.6	C	28551	55,-	17896
3er Set NOMAD LION					A-C	28550	125,-	BEST-PRICE %

GOLDTÜPFELFARN
PHEBODIUM
#28802



COBALT JUNGLE



COBALT JUNGLE PLANTERS / PFLANZGEFÄSSE

Ø	Ø	□	□	kg	multicolor	sales price excl. VAT			
						UVP zzgl. MwSt.	INLINER		
30	19.7	43	42.7	2.3	D	28563	105.-	19799	
47	30.7	62	61.7	5.5	E	28562	198.-	18614	
					2er Set COBALT JUNGLE	D-E	28561	275.- BEST-PRICE %	-

ENAMELED ALUMINIUM
EMAILLIERTES ALUMINIUM



COBALT JUNGLE TABLE TOP VASE / TISCHGEFÄSS

Ø	Ø	□	□	kg	multicolor	sales price excl. VAT			
						UVP zzgl. MwSt.	INLINER		
23	22	22	21.5	0.9	A	28567	35.-	17895	
27	25.5	25.5	25	1.3	B	28566	45.-	19799	
31	30	29	28.5	1.6	C	28565	55.-	17896	
					3er Set COBALT JUNGLE	A-C	28564	125.- BEST-PRICE %	-

ALOCASIA -
ELEFANTENOHR
#28429
on page · auf Seite 220



LUSH BOTANIC



LUSH BOTANIC PLANTERS / PFLANZGEFÄSSE

Ø	Ø	□	□	kg	multicolor	sales price excl. VAT UVP zzgl. MwSt.	INLINER
30	19.7	43	42.7	2.3	A	28577 105.-	19799
47	30.7	62	61.7	5.5	B	28576 198.-	18614
2er Set LUSH BOTANIC					A-B	28575 275.- BEST-PRICE	-



ENAMELED ALUMINIUM
EMAILLIERTES ALUMINIUM



LUSH BOTANIC TABLE TOP VASE / TISCHGEFÄSSE

Ø	Ø	□	□	kg	multicolor	sales price excl. VAT UVP zzgl. MwSt.	INLINER
23	22	22	21.5	0.9	C	28581 35.-	17895
27	25.5	25.5	25	1.3	D	28580 45.-	19799
31	30	29	28.5	1.6	E	28579 55.-	17896
3er Set LUSH BOTANIC					C-E	28578 125.- BEST-PRICE	-





BLOOMING NAMASTE

ENAMELED ALUMINIUM
EMAILLIERTES ALUMINIUM

BLOOMING NAMASTE PLANTERS / PFLANZGEFÄSSE

Ø	Ø	□	□	kg	multicolor	sales price excl. VAT	
						UVP zzgl. MwSt.	INLINER
30	19.7	43	42.7	2.3	A	28570	105,- 19799
47	30.7	62	61.7	5.5	B	28569	198,- 18614
3er Set BLOOMING NAMASTE					A-B	28568	275,- BEST PRICE 70%



BLOOMING NAMASTE TABLE TOP VASE / TISCHGEFÄSS

Ø	Ø	□	□	kg	multicolor	sales price excl. VAT	
						UVP zzgl. MwSt.	INLINER
23	22	22	21.5	0.9	C	28574	35,- 17895
27	25.5	25.5	25	1.3	D	28573	45,- 19799
31	30	29	28.5	1.6	E	28572	55,- 17896
3er Set BLOOMING NAMASTE					C-E	28571	125,- BEST PRICE 70%

LEMON FUSION



LEMON FUSION PLANTERS / PFLANZGEFÄSSE

Ø	Ø	□	□	kg	multicolor	sales price excl. VAT	
						UVP zzgl. MwSt.	INLINER
30	19.7	43	42.7	2.3	D	28556	105,- 19799
47	30.7	62	61.7	5.5	E	28555	198,- 18614
2er Set LEMON FUSION					D-E	28554	275,- BEST-PRICE %



ENAMELED ALUMINIUM
EMALLIERTES ALUMINIUM



LEMON FUSION TABLE TOP VASE / TISCHGEFÄSS

Ø	Ø	□	□	kg	multicolor	sales price excl. VAT	
						UVP zzgl. MwSt.	INLINER
23	22	22	21.5	0.9	A	28560	35,- 17895
27	25.5	25.5	25	1.3	B	28559	45,- 19799
31	30	29	28.5	1.6	C	28558	55,- 17896
3er Set LEMON FUSION					A-C	28557	125,- BEST-PRICE %





ROCCASTONE



	#	Sales price excl VAT UVP zzgl. MwSt.
 Swivel castors, each for Gelenkrollen, je Stück	28744	9,-



ROCCASTONE CUBE / PFLANZWÜRFEL

□	▤	□	▤	natur beton	anthracite	Sales price excl VAT UVP zzgl. MwSt.	castors Rollen
40 x 40	33 x 33	44	40	A 28498	F 28512	149,-	4 castors / Rollen
50 x 50	44 x 44	54	50	B 28499	G 28513	198,-	4 castors / Rollen
60 x 60	54 x 54	64	60	C 28500	H 28514	285,-	4 castors / Rollen
80 x 80	72 x 72	60	56	D 28501	I 28515	485,-	4 castors / Rollen
100 x 100	92 x 92	60	56	E 28502	J 28516	629,-	4 castors / Rollen



Easier planting thanks to the intermediate floor
Einfachere Bepflanzung dank Zwischenboden



Swivel castors, each for Gelenkrollen, je Stück # 28744 Sales price excl. VAT UVP zzgl. MwSt. 9,-

ROCCASTONE ROOM DIVIDERS / RAUMTEILER				Sales price excl. VAT UVP zzgl. MwSt.		Optional castors Optionale Rollen	
□	▣	□	▣	natur beton	anthracite	#	Price
100 x 35	93.5 x 28.5	60	50	A 28503	C 28517	28744	298,-
100 x 35	93.5 x 28.5	80	37.5	B 28504	D 28518	28744	365,-



ROCCASTONE

Thanks to its optional hidden casters room dividers are easy maneuverable.
Dank der optionalen verdeckten Rollen sind die Raumteiler leicht zu manövrieren.



Column

SÄULEN



ROCCASTONE COLUMN PLANTERS / PFLANZSÄULEN

□	▣	□	▣	natur beton	anthracite	Sales price excl. VAT UVP zzgl. MwSt.	INLINER
35 x 35	28,5 x 28,5	80	37	A 28505	C 28519	209,-	18612
35 x 35	28,5 x 28,5	100	37	B 28506	D 28520	249,-	18612



Straight or curved!

Gerade oder gerundet.

CONCRETE
BETON



ROCCASTONE FLOOR PLANTER / BODENGEFÄSS CYLINDER

Ø	Ø	□	□	natur beton	anthracite	Sales price excl. VAT UVP zzgl. MwSt.	
48	42	30	26	A 28509	C 28523	165,-	INLINER 18604
60	52	40	36	B 28510	D 28524	249,-	18606

ROCCASTONE FLOOR PLANTER / BODENGEFÄSS CLASSIC

Ø	Ø	□	□	natur beton	anthracite	Sales price excl. VAT UVP zzgl. MwSt.	
45	37	38	34	E 28507	G 28521	139,-	INLINER 18603
55	47	46	42	F 28508	H 28522	205,-	18605



OLIVENSTRAUCH -
OLEA EUROPAEA
#24408

OLIVENBAUM -
OLEA EUROPAEA
#23585

NEW!
NEU!



MODULO DIVIDER / RAUMTEILER

□	▢	□	▢	kg	teak natur	Sales price excl. VAT UVP zzgl. MwSt.
100 x 35	88 x 23	60	35	15	A 29343	549.-
100 x 35	88 x 23	80	35	19	B 29344	698.-

MODULO

Premium TEAK-Holz.



Easy planting and main-
tainance thanks to included
plant insert. Einfaches
Bepflanzen dank integriertem
Pflanzensatz

A-F
Supplied with removable
plant insert. Herausnehmbarer
Pflanzensatz inklusive.



MODULO PLANTERS / PFLANZGEFÄSSE

□	▢	□	▢	kg	teak natur	Sales price excl. VAT UVP zzgl. MwSt.
40 x 40	28 x 28	43	35	22	C 29338	279.-
51 x 51	39 x 39	43	35	25	D 29339	369.-
60 x 60	48 x 48	43	35	35	E 29340	459.-
80 x 80	68 x 68	43	35	35	F 29341	698.-



MODULO

Premium TEAK-Holz.



Supplied with removable plant insert. Herausnehmbarer Pflanzeinsatz inklusive.

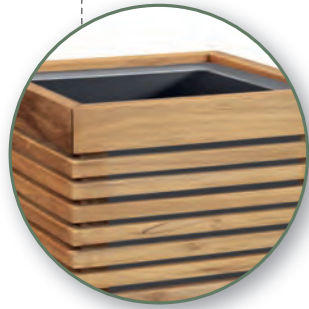

MODULO SITTING BENCH / SITZBANK

Ø	□	▣	kg	teak natur	Sales price excl. VAT UVP zzgl. MwSt.
211 x 51	43	35	67	A 29051	1.039,-
251 x 51	43	35	73	B 29053	1.159,-
262 x 51	43	35	71	C 29054	1.159,-
302 x 51	43	35	77	D 29055	1.259,-
160 x 51	43	-	63	- 29049	919,-
200 x 51	43	-	69	- 29050	1.039,-



NEW!
NEU!





False bottom for convenient planting
Zwischenboden für leichte Bepflanzung



False bottom for convenient planting
Zwischenboden für leichte Bepflanzung



B



A

Made from COCO SHELLS

SUSTAINABLE PRODUCT!
Upcycled coconut shell material.

NACHHALTIGES PRODUKT!
Upcycled mit Kokosnuss-Schalen.



COCONUT FLOOR VASE / BODENVASEN

Ø	Ø	□	□	kg		Sales price excl. VAT		
						UVP zzgl. MwSt.	INLINER	
39	33	75	31	10.8	A	28473	359,-	18603
46.5	42	90	32	16.3	B	28474	465,-	18605



COCONUT



ECO LOVE



A



B



A



SUSTAINABLE PRODUCT!
Upcycled coconut shell material.

NACHHALTIGES PRODUKT!
Upcycled mit Kokosnuss-Schalen.



COCONUT FLOOR PLANTERS / BODENGEFÄSSE

Ø	Ø	□	□	kg		Sales price excl VAT	INLINER
						UVP zzgl. MwSt.	
45	38.5	50	46	10.4	A	28478	265,- 18604
60	53.5	65	61	17.2	B	28479	498,- 18607





NATURAL BEAUTY

SUSTAINABLE PRODUCT!
Upcycled coconut shell material.

NACHHALTIGES PRODUKT!
Upcycled mit Kokosnuss-Schalen.



A



B



B



COCONUT PLANTERS / PFLANZGEFÄSSE GLOBE

Ø	Ø	□	□	kg		Sales price excl VAT	INLINER
						UVP zzgl. MwSt.	
50	28	40	39	8,15	A	28475	239.-
70	34	56	55	13,5	B	28476	379.-
							18604
							18607



HAND CRAFTED

SUSTAINABLE PRODUCT!
Upcycled coconut shell material.

NACHHALTIGES PRODUKT!
Upcycled mit Kokosnuss-Schalen.



B



A



COCONUT TABLE TOP VASE / TISCHGEFÄSS

Product	Ø	Ø	□	▣	kg		Sales price excl. VAT UVP zzgl. MwSt.
COCONUT planters / Tischgefäß	76x31	70x23	26,5	24	6	A	28480 269,-
COCONUT planters / Pflanzschale	43	37	22	20	4,2	B	28477 189,-



A



WOODEN BEAUTY

False bottom for convenient planting
Zwischenboden für leichte Bepflanzung

False bottom for convenient planting
Zwischenboden für leichte Bepflanzung



SUSTAINABLE PRODUCT!
Recycled Teak wood.

NACHHALTIGES PRODUKT!
Recyceltes Teak-Holz.



WOODY FLOOR VASE / BODENVASE

Ø	Ø	□	□	kg		sales price excl. VAT		
						UVP zzgl. MwSt.	INLINER	
39	33	75	30	8.9	A	28481	298,-	18603
46.5	43	90	34	14.9	B	28482	398,-	18605

NATURE meets ELEGANCE

ONLINE
DEAL



SUSTAINABLE PRODUCT!
Recycled Teak wood.

NACHHALTIGES PRODUKT!
Recyceltes Teak-Holz.



WOODY FLOOR PLANTERS / BODENGEFÄSSE

Ø	Ø	□	□	kg		sales price excl. VAT		
						UVP zzgl. MwSt.	INLINER	
46	38,5	50	45	8,7	A	28486	229.-	18604
60	55	65	60	13,3	B	28487	379.-	18607





ARTFUL WOOD



A

SUSTAINABLE PRODUCT!
Recycled Teak wood.

NACHHALTIGES PRODUKT!
Recyceltes Teak-Holz.



B



WOODY PLANTERS / PFLANZGEFÄSSE GLOBE

Ø	Ø	□	□	kg		sales price excl VAT UVP zzgl. MwSt.		INLINER
50	25	40	38	6.3	A	28483	229.-	18604
70	35	56	54	10.2	B	28484	335.-	18607



B





CRAFTED by NATURE



SUSTAINABLE PRODUCT!
Recycled Teak wood.

NACHHALTIGES PRODUKT!
Recyceltes Teak-Holz.



WOODY TABLE TOP VASE / TISCHGEFÄSSE

Ø	Ø	□	□	kg		sales price excl. VAT
43	37	22	20	2.95	A	28485
75x26.5	70x23	26.5	25	4.3	B	28488
						UVP zzgl. MwSt.
						155,-
						225,-



B



BANANAFLOOR PLANTERS / BODENGEFÄSSE

Ø	Ø	□	□	kg	banana	Sales price excl. VAT	
						UVP zzgl. MwSt.	INLINER
49	34	60	57	4	A 16832	398,-	18603
56	38	93	89	7.5	B 16757	639,-	18604



The vivid grain of the banana bark makes every single copy a unique piece of art.

Die lebendige Maserung der Bananenstaudenrinde macht jedes Stück zu einem faszinierenden Unikat.



B

Perfect by nature.

Von Natur aus perfekt.



GEWEIHFARN -
PLATYGERIUM
#24404

B

BANANA



BANANA PLANTERS / PFLANZGEFÄSSE GLOBE

Ø	Ø	□	□	kg	banana	Sales price excl. VAT	INLINER
						UVP zzgl. MwSt.	
30	15,5	30	24	1,5	A 22935	135,-	17895
50	18,5	40	38	3,5	B 22936	295,-	17896
70	30	62	59	7	C 22937	525,-	18603

DIVISION LITE



DIVISION LITE CUBE / PFLANZWÜRFEL

□	▣	▤	▥	kg	natur beton		anthracite		Sales price excl. VAT UVP zzgl. MwSt.		Optional castors Optionale Rollen	#	Sales price excl. VAT UVP zzgl. MwSt.		INLINER
40 x 40	34 x 34	44	40	5	A	22335-N	F	22334-N	169,-	4 pieces / Stück	28744	9,-	18604		
50 x 50	44 x 44	54	50	8,5	B	22337-N	G	22336-N	219,-	4 pieces / Stück	28744	9,-	18606		
60 x 60	54 x 54	64	60	10,5	C	22339-N	H	22338-N	298,-	4 pieces / Stück	28744	9,-	18608		
80 x 80	75 x 75	60	56	18	D	28369-N	I	28368-N	498,-	5 pieces / Stück	28744	9,-			
100 x 100	95 x 95	80	75	30	E	28367-N	J	28366-N	729,-	5 pieces / Stück	28744	9,-			



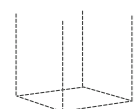

Easier planting thanks to the intermediate floor in the columns
Einfachere Bepflanzung dank Zwischenboden bei den Säulen.



DIVISION LITE COLUMN PLANTERS / PFLANZSÄULEN

□	▢	□	▢	kg	concrete stone grey	concrete anthracite	Sales price excl. VAT UVP zzgl. MwSt.	INLINER
35 x 35	30 x 30	80	40	10	A 22347-N	C 22346-N	219,-	17897
35 x 35	30 x 30	100	40	11	B 22343-N	D 22342-N	239,-	17897

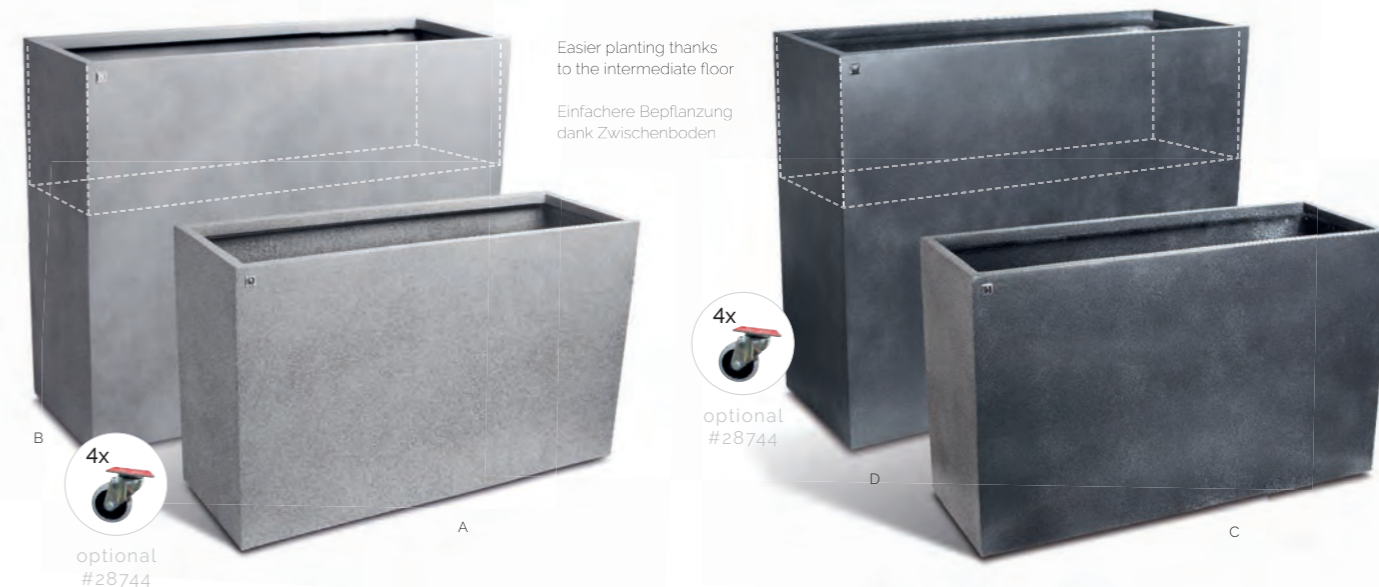

Easier planting thanks to the intermediate floor
Einfachere Bepflanzung dank Zwischenboden

4x optional #28744

DIVISION LITE ROOM DIVIDERS / RAUMTEILER

□	▢	□	▢	kg	concrete stone grey	concrete anthracite	Sales price excl. VAT UVP zzgl. MwSt.	Optional castors Optionale Rollen	#	Sales price excl. VAT UVP zzgl. MwSt.
100 x 35	93 x 28	60	54	15	A 22357-N	C 22356-N	369,-	4 pieces / Stück	28744	9,-
100 x 35	93 x 28	80	40	18	B 22359-N	D 22358-N	449,-	4 pieces / Stück	28744	9,-



optional  4x Swivel castors, each for Gelenkrollen, je Stück # 28744 Sales price excl. VAT UVP zzgl. MwSt. 9,-

Straight or curved!
Gerade oder gerundet.



DIVISION LITE FLOOR PLANTER / BODENGEFÄSS CYLINDER

Ø	Ø	□	▣	kg	concrete stone grey		concrete anthracite		Sales price excl. VAT UVP zzgl. MwSt.	
47	39	30	28	6	A	28717	D	28716	169,-	18605
60	50	40	32	11	B	28719	E	28718	298,-	18607
80	68	60	52	19,5	C	28721	F	28720	435,-	18610

DIVISION LITE FLOOR PLANTER / BODENGEFÄSS CLASSIC

Ø	Ø	□	▣	kg	concrete stone grey		concrete anthracite		Sales price excl. VAT UVP zzgl. MwSt.	
55	47	46	43	5,7	G	28723	J	28722	215,-	18606
65	56	54	53	6,5	H	28725	K	28724	315,-	18608
80	68	66	65	16,5	I	28727	L	28726	445,-	18610



Hidden castors and adjustable feet
optionally available
Verdeckte Gelenkrollen und höhenverstellbare Stellfüße
optional erhältlich



optional
#28744



optional
#28744



DIVISION LITE PLANTER BOX / PFLANZKASTEN

□	□	□	kg	stone grey	anthracite	Sales price excl. VAT UVP zzgl. MwSt.	Optional feet/castors Optionale Stellfüße/Rollen	#	Sales price excl. VAT UVP zzgl. MwSt.
80 x 35	35	28	13	A 28215-N	D 28216-N	239,-	4 pieces / Stück	28744	9,-
100 x 45	45	38	15	B 28212-N	E 28213-N	385,-	5 pieces / Stück	28744	9,-
150 x 50	50	42	36	C 28365-N	F 28364-N	549,-	5 pieces / Stück	28744	9,-

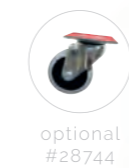

Super bowls!



DIVISION LITE PLANTERS XXL / BODENGEFÄSSE XXL

Ø	Ø	□	▣	kg	concrete stone grey	concrete anthracite	sales price excl. VAT UVP zzgl. MwSt.	Optional feet/castors Optionale Stellfüße/Rollen	#	Sales price excl. VAT UVP zzgl. MwSt.
100	88	50	43	19	A 28741	B 28740	589,-	5 pieces / Stück	28744	9,-
120	107	60	50	27	C 28743	D 28742	735,-	5 pieces / Stück	28744	9,-



CRASSULA OVATA
#20292

optional
#28744



4x



optional
#28744

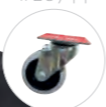

4x



Swivel castors, each for
Gelenkrollen, je Stück

#	Sales price excl. VAT UVP zzgl. MwSt.
28744	9,-



DIVISION LITE PLANTERS / PFLANZSCHALEN CURVED

Ø	Ø	□	□	kg	concrete stone grey	concrete anthracite	sales price excl. VAT UVP zzgl. MwSt.
55	41.5	25	22	5	A 28735	D 28734	185,-
73	59	33	24	10.5	B 28737	E 28736	249,-
95	78	44	37	16	C 28739	F 28738	359,-





STRIPE



A



CREME CHIC

False bottom for convenient planting
Zwischenboden für leichte Bepflanzung

False bottom for convenient planting
Zwischenboden für leichte Bepflanzung



B



A



STRIPE FLOOR VASE / BODENVASEN

Ø	Ø	□	▣	kg	cream creme	sales price excl. VAT UVP zzgl. MwSt.	INLINER
40	34.5	75	33	9.3	A 28468	245,-	18603
48	41	90	33	15.6	B 28469	349,-	18605





CREME DE LA CREME



C



A



B



STRIPE



STRIPE PLANTERS / PFLANZGEFÄSSE GLOBE

Ø	Ø	□	▣	kg	cream creme	sales price excl. VAT UVP zzgl. MwSt.	INLINER
50	27	40	37	7.4	A 28470	175.-	18604
70	37.5	56	52	14.3	B 28471	359.-	18607
75x26.5	68x21	26.5	24	6.8	C 28472	149.-	-

CURVED RIVER RIVER



FREE FLOW



False bottom for convenient planting
Zwischenboden für leichte Bepflanzung

False bottom for convenient planting
Zwischenboden für leichte Bepflanzung



ONLINE DEAL



CURVED RIVER FLOOR VASE / BODENVASEN

Ø	Ø	□	□	kg	sales price excl. VAT		sales price excl. VAT		INLINER		
					bronze	UVP zzgl. MwSt.	black iron	UVP zzgl. MwSt.			
40	33.5	75	33	11.5	A	28458	375,-	C	28463	298,-	18603
48	41	90	35	14.2	B	28459	529,-	D	28464	419,-	18605

THE MAGIC OF CURVES



ONLINE DEAL



CURVED RIVER PLANTERS / PFLANZGEFÄSSE GLOBE

Ø	Ø	□	□	kg	bronze		black iron		INLINER
					A	B	C	D	
50	27	40	36	4.5	28460	28461	28465	28466	18604
					sales price excl. VAT	sales price excl. VAT	sales price excl. VAT		
					UVP zzgl. MwSt.	UVP zzgl. MwSt.	UVP zzgl. MwSt.	UVP zzgl. MwSt.	
					269,-	535,-	215,-	435,-	18607



FLOW LIKE A BOAT



JADEBAUM
CRASSULA OVATA
#23835

A



A



B



CURVED RIVER TABLE TOP VASE / TISCHGEFÄSS

Ø	Ø	□	▣	kg	bronze	sales price excl VAT UVP zzgl. MwSt.	black iron	sales price excl VAT UVP zzgl. MwSt.
75x26,5	68x20	26,5	23	3,65	A 28462	249,-	B 28467	198,-



Amazing surface.
Faszinierende Oberfläche.



Ø	Ø	□	□	kg	black	Sales price excl. VAT		
						UVP zzgl. MwSt.	INLINER	
38	20	70	62	9.5	A	20672	209,-	17895
45	25	100	92	17	B	20673	355,-	18603
45	25	35	27	6.3	C	20674	169,-	17897
80	42	60	51	22.8	D	20675	535,-	18609
120	70	90	80	53.5	E	20676	1.525,-	18610
75x25	63x15	25	21	4.6	F	21726	155,-	-





ALUMINIUM



E



Ø	Ø	□	▣	kg	aluminium	Sales price excl. VAT	
						UVP zzgl. MwSt.	INLINER
38	20	70	62	6,5	A 20354	329,-	17895
45	25	100	92	12	B 20365	529,-	18603
45	25	35	27	5,3	C 20353	235,-	17897
80	42	60	51	16,8	D 20367	735,-	18609
120	70	90	80	42,5	E 20366	1.785,-	18610
75x25	63x15	25	21	3,7	F 21276	209,-	-



BOGENHANF -
SANSEVIERIA
CYLINDRICA
#20281



BRONZE

F



B

A

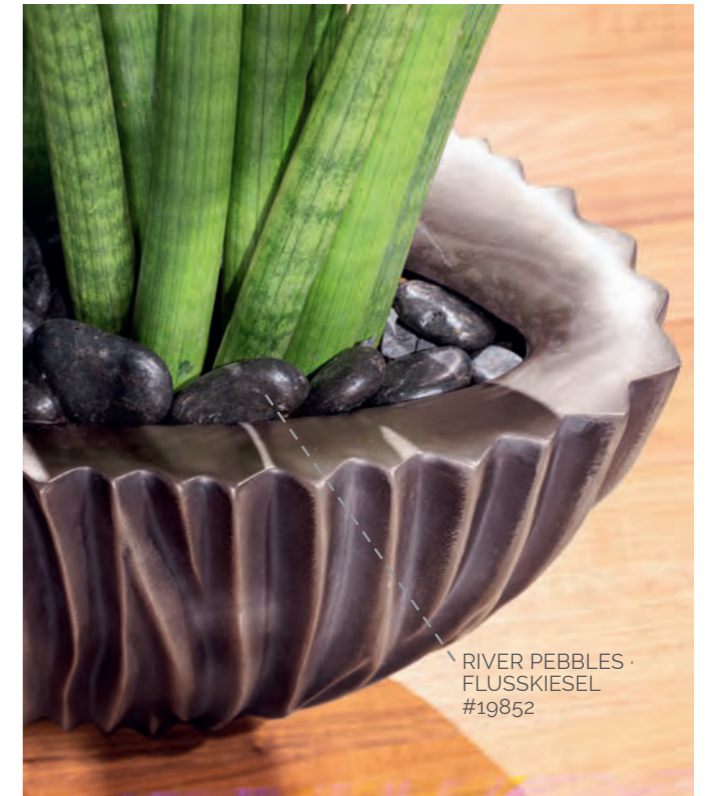

RIVER PEBBLES ·
FLUSSKIESEL
#19852



F

Ø	Ø	□	▣	kg	Sales price excl. VAT	
					bronze	INLINER
38	20	70	62	6.5	A 21038	409,- 17895
45	25	100	92	12	B 21039	655,- 18603
45	25	35	27	5.3	C 21037	285,- 17897
80	42	60	51	16.8	D 21041	895,- 18609
120	70	90	80	42.5	E 21040	2.195,- 18610
75x25	63x15	25	21	3.7	F 21275	259,- -



E

D

C



BLACK IRON



C



MATCHING INSERTS NOT INCLUDED!
PASSENDE EINSÄTZE NICHT INKLUSIVE!

INLINER	
A	22985
B	22985
C	22985

180 cm



LOFT FLOOR VASE / BODENVASE

Ø	Ø	□	▣	kg	black iron	sales price excl. VAT UVP zzgl. MwSt.
30	22	80	77	9.4	A 23065	215,-
31	22	100	97	11.7	B 23069	275,-
32	22	120	117	16	C 23073	298,-



MATCHING INSERTS NOT INCLUDED!
PASSENDE EINSÄTZE NICHT INKLUSIVE!

INLINER	
A	22985
B	22985
C	22985

180 cm



A



B



C



LOFT FLOOR VASE / BODENVASE

Ø	Ø	□	□	kg	aluminium	sales price excl. VAT UVP zzgl. MwSt.
30	22	80	77	9.4	A 23063	235.-
31	22	100	97	11.7	B 23067	295.-
32	22	120	117	16	C 23071	349.-

"GOOD OLD" LOFT



ALUMINIUM

A



B



BRONZE



MATCHING INSERTS NOT INCLUDED!
PASSENDE EINSÄTZE NICHT INKLUSIVE!

INLINER

A	22985
B	22985
C	22985



A



B



C



LOFT FLOOR VASE / BODENVASEN

Ø	Ø	□	□	kg	verdigris bronze	sales price excl. VAT UVP zzgl. MwSt.
30	22	80	77	9.4	A 23066	235,-
31	22	100	97	11.7	B 23070	295,-
32	22	120	117	16	C 23074	349,-



Passgenaue
Pflanzeinsätze
erhältlich.



LOFT FLOOR PLANTERS / BODENGEFÄSSE

Ø	Ø	□	□	kg	black iron	UVP zzgl. MwSt.	aluminium	verdigris bronze	UVP zzgl. MwSt.	INLINER
50	38	40	39	5.3	A 19412	239,-	C 19411	E 28495	295,-	18604
68	46	55	54	9.8	B 19414	419,-	D 19413	F 28496	525,-	18607

"GOOD OLD" LOFT



BLACK IRON



AMAZING GRACE



GRACE PFLANZGEFÄSSE

Ø	Ø	□	□	kg		champagner gold + patina	Sales price excl. VAT UVP zzgl. MwSt.	INLINER
31	23	70	56	8	A	24178	198,-	17895
37	29	90	76	13,5	B	24179	249,-	17896
52	44	120	106	17	C	24180	398,-	18605
41	33	41	39	4,5	D	24175	135,-	18603
50	42	50	48	5	E	24206	198,-	18605
67	59	67	65	7,5	F	24176	325,-	18608
80	72	80	78	16	G	24177	419,-	18610



OLIVENBAUM,
245 cm
#23586

OLIVENBAUM,
150 cm
#23575





TIMELESS TERRA



CORTEN STEEL PLANTERS / RAUMTEILER

□	▢	□	▢	kg	rost	sales price excl. VAT UVP zzgl. MwSt.	INLINER	
78x28	74x24	78	76	23	A	28644	379,-	17896
118x38	114x34	118	116	61	B	28645	839,-	18603



CORTEN STEEL PLANTERS / PFLANZWÜRFEL

□	▢	□	▢	kg	rost	sales price excl. VAT UVP zzgl. MwSt.	INLINER	
38	34	38	36	13.5	A	28639	209,-	18612
48	44	48	46	20.8	B	28640	319,-	18613
58	54	58	56	29.8	C	28641	429,-	18607
68	64	68	66	40.3	D	28642	559,-	18609
78	74	78	76	52.4	E	28643	719,-	18610

ORIGINAL CORTEN STEEL
Stable rust-like appearance
after exposure to the weather,
known for its corrosion resistance
and distinctive look.

2,0 mm material thickness
4 cm rim thickness

ORIGINAL CORTENSTAHL
Stabiler rostähnlicher Look
nach Witterungseinflüssen,
bekannt für seine Korrosionsbeständigkeit
und unverwechselbares Erscheinung.

2,0 mm Materialstärke
4 cm breiter Rand





NEW!
NEU!



CLOUD



PLANTERS / PFLANZGEFÄSSE

Ø	Ø	□	■	kg	anthracite		grey		Sales price excl. VAT	
									UVP zzgl. MwSt.	INLINER
42.5	38.5	48	45	5	A	28408	D	28410	199,-	18604
53	47	60	56	6.65	B	28411	E	28413	329,-	18606
66	59.5	74	70	9	C	28414	F	28416	459,-	18608





Fascinating PATINA.

The basis of the noble PANDORA planters is a fibreglass body, which has been coated with a gold leaf look. A counterweight in the bottom of the container ensures a secure stand.

Die Basis der edlen PANDORA Pflanzgefäße bildet ein Fiberglaskorpus, der mit einer Blattgold-Optik beschichtet wurde. Ein Kontergewicht im Gefäßboden sorgt für einen sicheren Stand.



PANDORA FLOOR VASES / BODENVASEN

Ø	Ø	□	□	kg	Sales price excl. VAT		
					gold leaf	UVP zzgl. MwSt.	INLINER
35	25	90	26	9.5	A 18420	365,-	17895
50	41	90	37	13	B 17308	545,-	18604
35	25	125	29	12	C 18422	475,-	17895
50	41	125	37	15.5	D 17311	715,-	18604
55	46.5	50	44	4.8	E 28419	409,-	18605
70	60.5	63.5	55	8.9	F 28422	625,-	18608





Decorative silver.

The basis of the noble PANDORA planters is a fibreglass body, which has been coated with a silver leaf look. A counterweight in the bottom of the container ensures a secure stand.

Die Basis der edlen PANDORA Pflanzgefäße bildet ein Fiberglaskorpus, der mit einer Blattsilber-Optik beschichtet wurde. Ein Kontergewicht im Gefäßboden sorgt für einen sicheren Stand.

A-D

False bottom for convenient planting
Zwischenboden für leichte Bepflanzung



PANDORA FLOOR VASES / BODENVASEN

Ø	Ø	□	□	kg	Sales price excl. VAT		
					silver leaf	UVP zzgl. MwSt.	INLINER
35	25	90	26	9,5	A 18419	365,-	17895
50	41	90	37	13	B 17307	545,-	18604
35	25	125	29	12	C 18421	475,-	17895
50	41	125	37	15,5	D 17310	715,-	18604
55	46,5	50	44	4,8	E 28420	409,-	18605
70	60,5	63,5	55	8,9	F 28423	625,-	18608



Pieces of ART. Kunstwerke.

Soberly considered, it is nothing more than a chemical reaction, but when you see the fascinating play of colours it creates – from orange to purple to iridescent violet and green-blue to shimmering anthracite – you can only marvel. The new PANDORA OXIDIZED vessels - true works of art.

Nüchtern betrachtet, ist es nichts weiter als eine chemische Reaktion, doch wenn man sieht, was für ein faszinierendes Farbenspiel dadurch entsteht – von Orange zu Purpur hin zu schillerndem Violett und Grünblau bis zu irisierendem Anthrazit – kann man nur noch staunen. Die neuen PANDORA OXIDIZED Gefäße – wahre Kunstwerke.

A-D
False bottom for convenient planting
Zwischenboden für leichte Bepflanzung



PANDORA FLOOR VASES / BODENVASEN

Ø	Ø	□	■	kg	brass oxidized Messing oxidiert	Sales price excl. VAT UVP zzgl. MwSt.	INLINER
35	25	90	26	9,5	A 23090	415,-	17895
50	41	90	37	13	B 23818	598,-	18604
35	25	125	29	12	C 23819	529,-	17895
50	41	125	37	15,5	D 23820	779,-	18604
55	46,5	50	44	4,8	E 28421	449,-	18605
70	60,5	63,5	55	8,9	F 28424	685,-	18608

JADE PLANT
#23835

ALOE WITH BLOSSOM
ALOE MIT BLÜTE
#23834





SPATHIPHYLLUM -
EINBLATT
#28825



CIGAR FLOOR PLANTERS / VASE · BODENGEFÄSSE / -VASEN

Ø	Ø	□	▣	kg	grey/grau	Sales price excl. VAT	
						UVP zzgl. MwSt.	INLINER
39	27,5	45	41	4,55	A 28417	165,-	17897
47	35	55	50	8,6	B 17909	295,-	18607
60	48	70	65	11,0	C 28418	445,-	18607
50	39	100	93	11,5	D 17910	475,-	18604
54	38	150	148	24,8	E 17911	635,-	18604



CIGAR



MATCHING INSERTS NOT INCLUDED!
PASSENDE EINSÄTZE NICHT INKLUSIVE!

INLINER
20021

CIGAR OXIDIZED

∅ ∅ □ □ kg
42 30 100 94 6,5

mystic silver
24115

Sales price
excl. VAT
UVP zzgl. MwSt.
498,-



CALATHEA -
KORBMARANTE
#23585

MATCHING INSERTS NOT INCLUDED!
PASSENDE EINSÄTZE NICHT INKLUSIVE!

INLINER
20021

blue flame
24116

Sales price
excl. VAT
UVP zzgl. MwSt.
498,-





False bottom for convenient planting
Zwischenboden für leichte Bepflanzung

False bottom for convenient planting
Zwischenboden für leichte Bepflanzung

False bottom for convenient planting
Zwischenboden für leichte Bepflanzung



C



B



A



TALON FLOOR VASE / BODENVASE

Ø	Ø	□	□	kg	black	sales price excl. VAT UVP zzgl. MwSt.	INLINER
40	33.5	75	36	9,6	A 28455	265,-	18603
48	41.5	90	32	15,6	B 28456	369,-	18605
57	50.5	120	39	24,7	C 28457	575,-	18606



B

BLACK BEAUTY





ELEGANT ALUMINIUM



False bottom for convenient planting
Zwischenboden für leichte Bepflanzung

False bottom for convenient planting
Zwischenboden für leichte Bepflanzung

False bottom for convenient planting
Zwischenboden für leichte Bepflanzung



C



B



A



TALON FLOOR VASE / BODENVASE

Ø	Ø	□	▣	kg	aluminium	sales price excl. VAT		
						UVP zzgl. MwSt.	INLINER	
40	33.5	75	36	10.9	A	28452	319.-	18603
48	41.5	90	32	13.2	B	28453	435.-	18605
57	50.5	120	39	17.4	C	28454	669.-	18606



Upper class.
Oberklasse.



Removable plant insert included.
Herausnehmbarer Pflanzeinsatz inklusive.

Easy planting and maintenance thanks to included plant insert. *Einfaches Bepflanzen dank integriertem Pflanzeinsatz.*



ROYAL FLOOR PLANTERS / BODENVASE LUNA

Ø	Ø	□	□	kg	champagner-rosé	Sales price excl. VAT UVP zzgl. MwSt.
34	24	75	30	14,0	A 22126	335,-
34	24	97	30	19,0	B 22124	419,-
34	24	117	30	24,0	C 22122	498,-



HORSETAIL REED
SCHACHTELHALM
#21540



B



B

A

ROYAL FLOOR PLANTERS / BODENVASE ESSENCE

Ø	Ø	□	□	kg	champagner-rosé	Sales price excl. VAT UVP zzgl. MwSt.
37	24	80	30	11	A 22120	365,-
46	27	100	30	16,5	B 22118	565,-

Supplied with removable plant insert. Herausnehmbarer Pflanzeinsatz inklusive.



FICUS BONSAI
#23573



Impressive. Beeindruckend.

ROYAL is one of our most popular series.
A silver leafed body with an impressive
color finish and unique matt coating.

ROYAL ist eine unserer beliebtesten Serien.
Ein blattversilberter Korpus mit beeindruckender
Farbgebung und einzigartigem Matt-Finish.



ROYAL PLANTERS / PFLANZGEFÄSSE

Ø	Ø	□	□	kg		bronze	champagner rosé	Sales price excl. VAT UVP zzgl. MwSt.	INLINER
36	30	55	53	4.0	A	24066	C 24065	249,-	17897
46	38	67	66	6.0	B	24064	D 24063	398,-	18604



URBAN

OLIVE TREE
OLIVENBAUM
#23586

Flat bottom shape.

Flachbodenform.

The flat bottom shape is ideal for large and high plants that need a secure stand. In this way you can also give large solitary plants an impressive appearance. ROYAL is one of our most popular series. A silver leafed body with an impressive color finish and unique matt coating.

Besonders für große und hohe Bepflanzungen, die einen sicheren Stand brauchen, ist die Flachbodenform ideal. So verschaffen Sie auch großen Solitärpflanzen einen beeindruckenden Auftritt. ROYAL ist eine unserer beliebtesten Serien. Ein blattversilberter Korpus mit beeindruckender Farbgebung und einzigartigem Matt-Finish.



ROYAL

ROYAL FLOOR PLANTERS / BODENGEFÄSSE

Ø	Ø	□	□	kg		bronze	champagner rosé	Sales price excl. VAT UVP zzgl. MwSt.	INLINER	
50	43	45	43	5,5	A	24062	C	24060	359,-	18605
65	56	58	57	9,5	B	24061	D	24059	545,-	18607

Discreet.
Dezent.

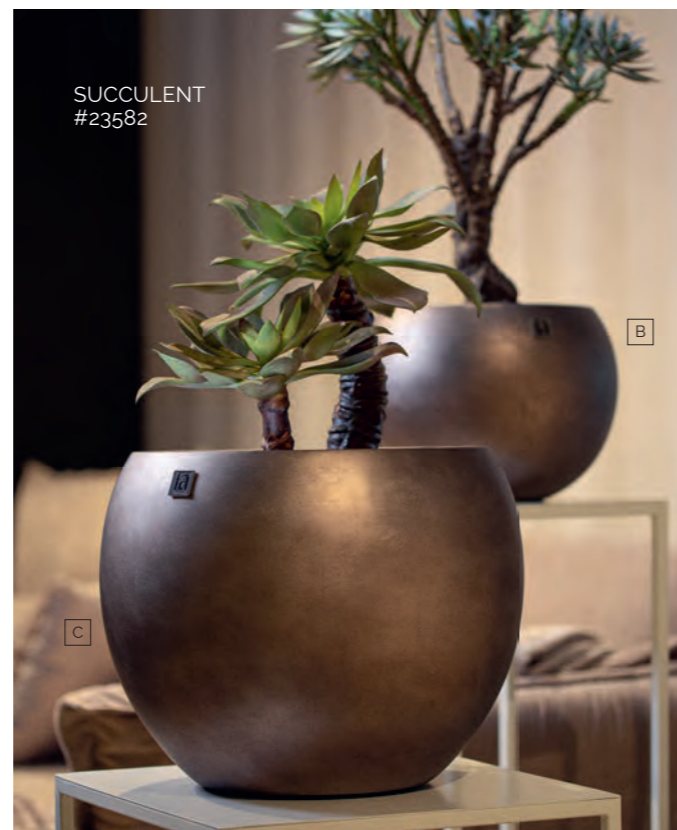

ROYAL PLANTERS / PFLANZGEFÄSSE GLOBE

Ø	Ø	□	▣	kg	champagner-rosé	Sales price excl VAT	
						UVP zzgl. MwSt.	INLINER
17	13	24	9	1.5	A 23086	55,-	-
30	18	24	20	1.0	B 23088	119,-	17895
40	26	32	30	2.5	C 22114	185,-	17897
60	42	43	40	4.5	D 22112	385,-	18604



ROYAL



A



Inside is matt coated!
Can be used as a decorative bowl as well.
Innen matt lackiert!
Auch als Dekoschale einsetzbar.



B



A



ROYAL TABLE PLANTERS / TISCHGEFÄSSE

Ø	Ø	□	□	kg	champagner-rosé	Sales price excl. VAT UVP zzgl. MwSt.
48 x 22	38 x 15	17	15	1,5	A 22106	99,-
65 x 13	63 x 11	15	10	1,5	B 22110	125,-

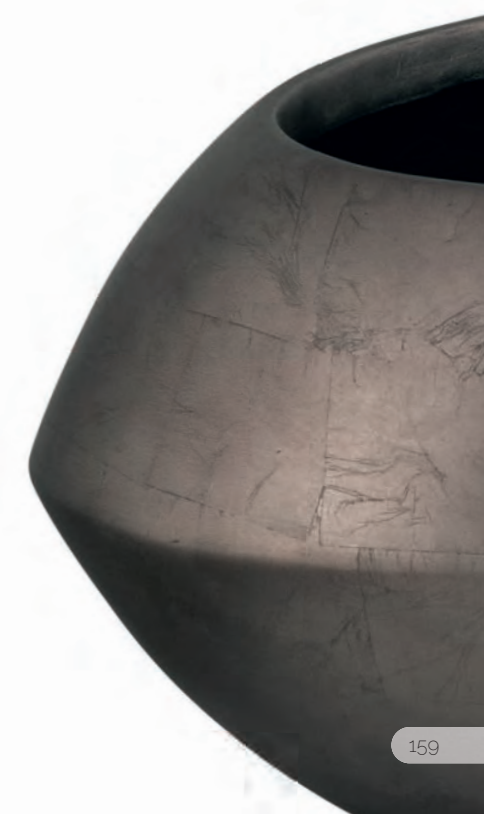

High-class.
Hochklassig.

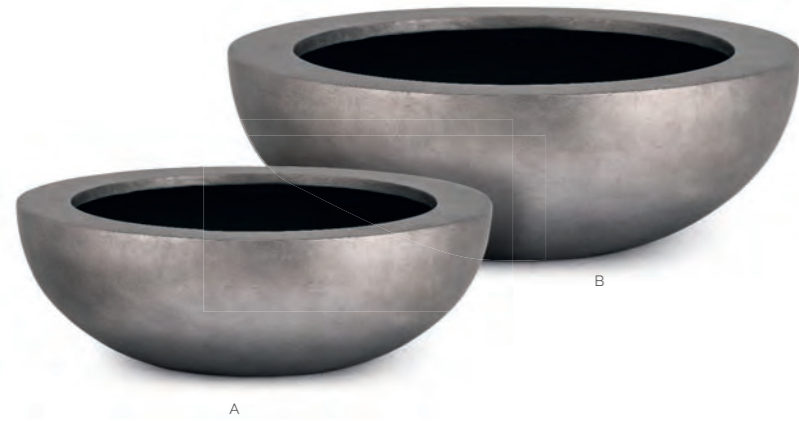

ROYAL PEDESTAL · BOWLS / PODEST · SCHALEN

Ø	Ø	□	□	kg	champagner-rosé	Sales price excl. VAT UVP zzgl. MwSt.
42	30	14	13	1,5	A 22102	125,-
55	43	18	17	3,5	B 22100	169,-
35 x 35	-	100	-	18,5	C 22116	598,-



ROYAL





A

STAGE
BLUMENSÄULE
#23056

UNIQUE

Einzigartig



CROC FLOOR PLANTERS / BODENGEFÄSSE

Ø	Ø	□	□	kg	bronze	Sales price excl. VAT UVP zzgl. MwSt.	INLINER
47	36	56	50	6.5	A 24578	279.-	18605
50	39	100	95	21.5	B 26992	445.-	18605



ALOE WITH BLOSSOM
ALOE MIT BLÜTE
#23834

ROCKY



BEGONIA
#24395 #23572

Raw beauties.
Rauhe Schönheiten.



ROCKY FLOOR PLANTERS / FLOOR VASES / BODENGEFÄSSE / BODENVASEN

Ø	Ø	□	▣	kg		Sales price excl. VAT		Sales price excl. VAT			
						bronze	black granit	UVP zzgl. MwSt.	INLINER		
35	30	79	69	9	A	24127	245.-	E	24165	179.-	17897
43	37	100	88	14	B	24128	329.-	F	24166	275.-	18603
60	37	43	33	6.5	C	24129	269.-	G	24167	198.-	18603
80	48	57	52	10.5	D	24130	395.-	H	24168	349.-	18605



DO DAN TREE
#24402



CORAL

STAGE SÄULE
#23056 #23050
on page · auf Seite 180



CORAL PLANTERS / PFLANZGEFÄSSE

Ø	Ø	□	▣	kg	bronze patina	Sales price excl. VAT UVP zzgl. MwSt.	INLINER
41	35	41	38	5	A 25375	169.-	18603
50	49	50	48	6,5	B 25376	229.-	18605
67	63	67	62	12	C 25526	335.-	18608
80	78	80	77	16,5	D 25527	455.-	18610





ANTHURIUM
#24399

MEDINILLA
#23842



CORAL.

bronze patina



CORAL FLOOR VASE / BODENVASEN

Ø	Ø	□	▣	kg	bronze patina	Sales price excl. VAT		
						UVP zzgl. MwSt.	INLINER	
31	24	70	65	11	A	25528	198.-	17896
37	29	90	85	16,5	B	25529	269.-	18614
52	42	120	115	21	C	25530	435.-	18605



ATLANTIS



BRONZE oxydized

EUCALYPTUS
#24407



ATLANTIS PLANTERS / PFLANZGEFÄSSE

Ø	Ø	□	□	kg	oxidized bronze	sales price excl VAT UVP zzgl MwSt.	INLINER
80	72	80	78	16	A 28401	559.- €	18610
67	59	67	65	7.5	B 28400	395.- €	18608
50	42	50	48	5	C 28399	229.- €	18605
41	33	41	39	2.5	D 28395	169.- €	18604
52	44	120	106	17	E 28398	455.- €	18605
37	29	90	76	13.5	F 28396	298.- €	17897
31	23	70	56	8	G 28397	239.- €	17896



SUCCULENT
#23582



A4

B4



A3

A1

A2

B3

B1

B2



LAVA FLOOR PLANTERS / PFLANZGEFÄSSE

Ø	Ø	□	□	kg	bronze patina		grey wash		Sales price excl. VAT	
									UVP zzgl. MwSt.	INLINER
29	23	38	34	3	A1	24862	B1	24863	119,-	17896
44	37	53	47	7	A2	24860	B2	24866	198,-	18604
46	40	40	35	6	A3	24859	B3	24865	169,-	18604
56	49	103	94	21	A4	27386	B4	27387	398,-	18606



STAGHORN FERN
GEWEIHFARN
#24404

LAVA





MEDINILLA
#23842



MAGNIFICO



FLOWERING ALOE
BLUHENDE ALOE
#24406



RIVER PEBBLES -
FLUSSKIESEL
#19849
on page - auf Seite 197



MAGNIFICO PFLANZGEFÄSSE

Ø	Ø	□	▣	kg	antique bronze antik-bronze	Sales price excl. VAT	
						UVP zzgl. MwSt.	INLINER
47	43	40	37	2,9	A 24181	185,-	18604
56	49	47	45	4	B 24204	249,-	18606
35	27	72	63	8,6	C 24182	325,-	18614
46	42	92	90	12	D 24183	398,-	18604



CLASSIC SHAPES WITH INTERESTING GRANITE SURFACE
KLASSISCHE FORM MIT INTERESSANTER GRANIT OBERFLÄCHE



anthracite

A

B

C



stone grey

F

E

D



CLIFF PLANTERS / PFLANZGEFÄSS

Ø	Ø	□	▣	kg	granit finish anthracite RAL 7021		granit finish stone grey RAL 7030		Sales price excl. VAT	
									UVP zzgl. MwSt.	INLINER
27	23	30	28	2	A	27753	D	27754	98,-	17896
37	33	45	41	3	B	27828	E	27829	145,-	18603
49	44	55	53	5	C	27830	F	27759	189,-	18605

CLIFF



ALOE
Art. # 24406





FENSTERBLATT - MONSTERA
#28448



CORUM



A1

A2



B1

B2



C1

C2



All CORUM planters come in a matte colour finish

Alle CORUM Gefäße zeichnen sich durch ein mattes Farbfinish aus.

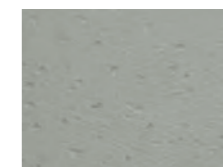

stone grey RAL 7030

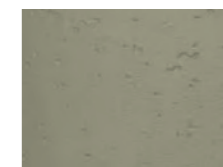

olive grey RAL 7002

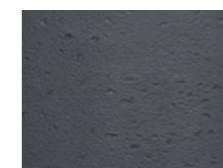

anthracite RAL 7021



CORUM PLANTERS / PFLANZGEFÄSSE

Ø	□	■		concrete finish stone grey RAL 7030		concrete finish olive grey RAL 7002		concrete finish anthracite RAL 7021		Sales price excl. VAT UVP zzgl. MwSt.	INLINER
				A1	B1	C1	A2	B2	C2		
39	37	28	A1	27706	B1	27704	C1	27705	115,-	18603	
48.5	46.5	36	A2	27709	B2	27707	C2	27708	155,-	18605	



FÄCHERPALME
#24410

GEWEIHFARN - PLATYCERIUM
#24404

CONICAL

concrete finish



A3

A1

A2



B3

B1

B2



C3

C1

C2



CONICAL PLANTERS / PFLANZGEFÄSSE

Ø	Ø	□	□	kg	concrete finish anthracite RAL 7021		concrete finish stone grey RAL 7030		concrete finish traffic white RAL 9016		Sales price excl. VAT UVP zzgl. MwSt.	INLINER
40	34	35	35	2,5	A1	27810	B1	27796	C1	27797	115,-	18603
50	42	40	39	3,5	A2	27809	B2	27801	C2	27802	145,-	18605
58	49	50	48	4	A3	27808	B3	27806	C3	27807	198,-	18607



SHELL BOWLS / SCHALEN
#19581

Staged.

In Szene gesetzt.



Light-weight yet sturdy platforms in matt powder-coated metal.
Leichtgewichtige und dennoch stabile Podeste aus matt pulverbeschichtetem Metall.

STAGE PEDESTALS / PODESTE

□	□	kg	black schwarz		white weiß	Sales price excl VAT UVP zzgl. MwSt.	
30 x 30	50	4.0	G	27998	N	27999	119.-
30 x 30	75	4.6	A	23048	H	23049	135.-
30 x 30	100	4.9	B	23050	I	23051	149.-
30 x 30	125	6.0	C	23052	J	23053	165.-
40 x 40	50	5.5	D	23054	K	23055	139.-
40 x 40	75	6.0	E	23056	L	23057	159.-
40 x 40	100	6.5	F	23058	M	23059	175.-

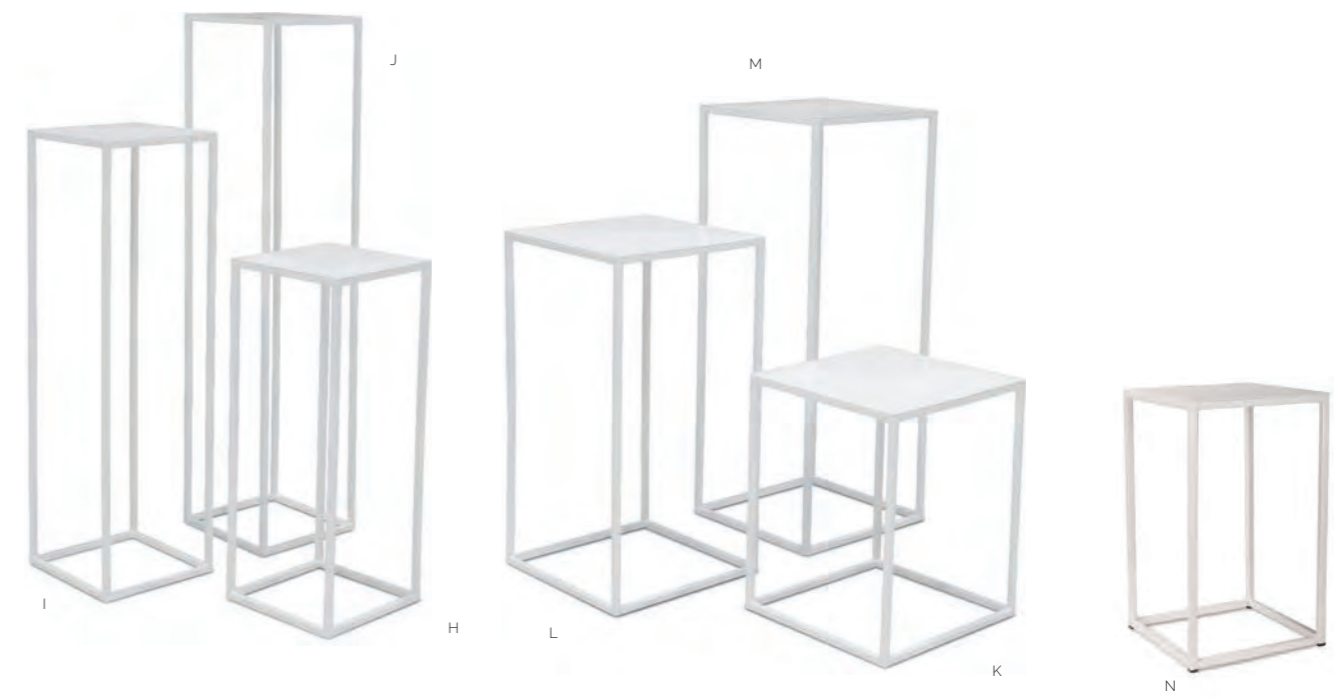



THE OPTIONS

DIE OPTIONEN



Hidden wheels
verdeckte Gelenkrollen
(19778)



Hidden adjustable feet
verdeckte Stellfüße
(19780)

Cubes		✓	✓
Divider		✓	✓
Tower			✓
Pandora			
XL		✓	✓
Globe			

Colours Farben	white	 RAL 7016 anthrazit-grau RAL 9016 weiß RAL 7039 Quarzgrau RAL 9005 schwarz	 B1
Delivery time Lieferzeit	On stock auf Lager	4 weeks	6 weeks
Surcharge Aufpreis	free kostenfrei	free kostenfrei	10-19 pcs / Stk. 25 % 20-49 pcs / Stk. 20 % 50-99 pcs / Stk. 5 % >= 100 pcs / Stk. free

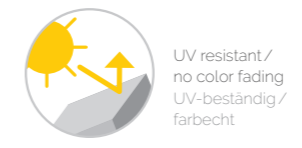
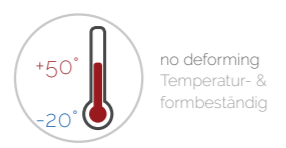

Marine Quality. Marine-Qualität.



The planters of the PREMIUM COLLECTION consist of a robust glass fibre reinforced plastic with a 2 mm thick gelcoat coating in marine quality. This durable composite material is characterised by its particularly high weather resistance, UV stability, chemical and acid resistance as well as high impact and scratch resistance. The material known from yacht building remains waterproof, crack-free and osmosis-resistant for years. The double-walled planters ensure tasteful planting both indoors and outdoors thanks to a drain with twist closure. Retracted intermediate bottoms and counterweights guarantee maximum user-friendliness for the high planters. Various optional accessories such as adjustable feet, base plates, swivel castors and screw foundation ensure more flexibility and increase the stability of the beautifully designed planters.

Die Pflanzgefäße der PREMIUM COLLECTION bestehen aus einem robusten glasfaserverstärkten Kunststoff mit einer ca. 2 mm starken Gelcoat-Beschichtung in Marine-Qualität. Dieser langlebige Verbundwerkstoff zeichnet sich durch seine besonders hohe Witterungsbeständigkeit, UV-Stabilität, Chemikalien- und Säureresistenz, sowie eine hohe Schlag- und Kratzfestigkeit aus. Das aus dem Yachtbau bekannte Material bleibt auch über Jahre wasserundurchlässig, rissfrei und osmosebeständig. Die doppelwandigen Pflanzgefäße sorgen dank eines Abflusses mit Drehverschluss sowohl im Innen- als auch Außenbereich für eine geschmackvolle Begrünung. Eingezogene Zwischenböden und Kontergewichte garantieren maximale Benutzerfreundlichkeit bei den hohen Gefäßen. Verschiedene, optional erhältliche Zubehörartikel wie Stellfüße, Bodenplatten, Gelenkrollen und Schraubfundament sorgen für mehr Flexibilität und erhöhen die Standsicherheit der formschönen Pflanzgefäße.



Classical, cubical.

Klassisch kubisch.



New seamless production technique with visually improved, broader rim. Neue nahtlose Fertigungstechnik mit schönerem, breiterem Rand.



optional for all planters



See first chapter page for color options and detailed material characteristics! Farboptionen und ausführliche Materialeigenschaften siehe erste Kapitelseite!



Hidden wheels and adjustable feet optionally available. Verdeckte Gelenkrollen und höhenverstellbare Stellfüße optional erhältlich



For/für A-C: casters - Gelenkrollen (1x)	19778	9,-
feet - Stellfüße (1x)	19780	3,50

PREMIUM PLANTER CUBE / PFLANZWÜRFEL

□	📏	□	📏	kg	white Weiß	black Schwarz	RAL 7016 anthracite grey Anthrazitgrau	RAL 7039 quartz grey Quarzgrau	Sales price excl. VAT UVP zzgl. MwSt.	Optional feet/casters Optionale Stellfüße/Rollen
40x40	31	40	33	5.1	A 19957	20604	20648	20125	269,-	4 pieces / Stück
50x50	39	50	46	6.9	B 19958	20605	20581	20652	335,-	4 pieces / Stück
60x60	47	60	54	9.7	C 19959	20606	20582	20102	525,-	4 pieces / Stück
80x80	61.5	80	67	21.6	D 19960	20607	20583	20653	935,-	4 pieces / Stück
100x100	77	100	87	36.7	E 19961	20608	20584	20654	1679,-	4 pieces / Stück



CUBE





BIGGER.



A



optional for all planters



B

A



C



D



For/für A-D. casters · Gelenkrollen (1x)	19778	9,-
feet · Stellfüße (1x)	19780	3,50



See first chapter page for color options and detailed material characteristics!
Farboptionen und ausführliche Materialeigenschaften siehe erste Kapitelseite!

PREMIUM CLASSIC FLOOR PLANTER / BODENGEFÄSS

Ø	Ø	□	□	kg	white Weiß	black Schwarz	RAL 7016 anthracite grey Anthrazitgrau	RAL 7039 quartz grey Quarzgrau	Sales price excl. VAT UVP zzgl. MwSt.
100	84	50	37	13,5	A 23949	B 23952	C 23950	D 23951	805,-



KOBRALILIE -
DARLINGTONIA
#23587

XL. STYLE AT LARGE.





PREMIUM



ONION GRASS
ZWIEBELGRAS
#21804
on page · auf Seite 213



DIVIDER



See first chapter page for color options and detailed material characteristics!
Farboptionen und ausführliche Materialeigenschaften siehe erste Kapitelseite!



optional for all planters

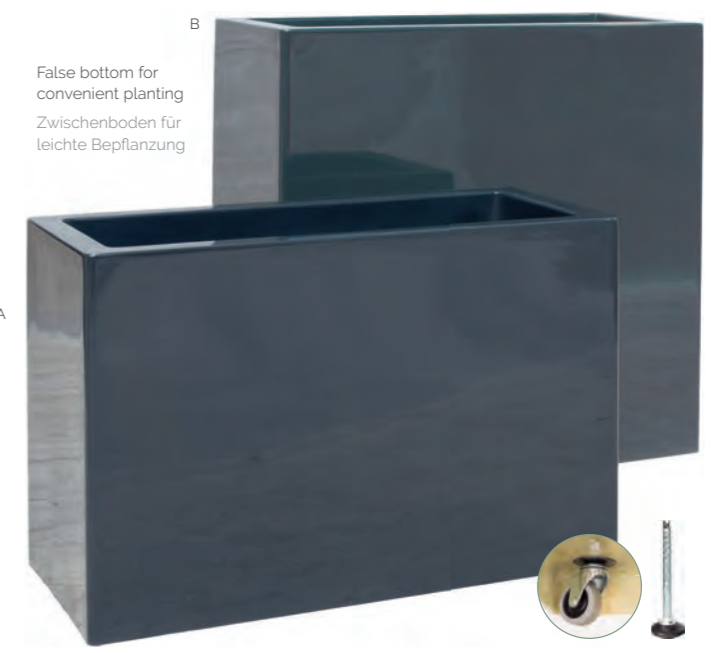

False bottom for convenient planting
Zwischenboden für leichte Bepflanzung



For/für A-D: casters · Gelenkrollen (1x)	19778	9,-
feet · Stellfüße (1x)	19780	3,50

				kg	white Weiß	black Schwarz	anthracite grey Anthrazitgrau	quartz grey Quarzgrau	Sales price excl. VAT UVP zzgl. MwSt.	Optional feet/casters Optionale Stellfüße/Rollen
90 x 40	80 x 30	60	35	10,4	A 22310	22315	22325	22320	505,-	4 pieces / Stück
90 x 40	80 x 30	90	35	12,6	B 22311	22316	22326	22321	639,-	4 pieces / Stück



TOWER

Seamless production technique with broad rim.
Nahtlose Fertigungstechnik mit schönem, breitem Rand.

False bottom for convenient planting
Zwischenboden für leichte Bepflanzung



For/für A-D: casters · Gelenkrollen (1x)	19778	9,-
feet · Stellfüße (1x)	19780	3,50

				kg	white Weiß	black Schwarz	RAL 7016 anthracite grey Anthrazitgrau	RAL 7039 quartz grey Quarzgrau	Sales price excl. VAT UVP zzgl. MwSt.	Optional feet Optionale Stellfüße
40	30	50	36	5,1	C 22307	22312	22322	22317	315,-	4 pieces / Stück
40	30	90	36	6,5	D 22308	22313	22323	22318	449,-	4 pieces / Stück



Ø	Ø	□	□	kg	white Weiß	black Schwarz	RAL 7016 anthracite grey Anthrazitgrau	RAL 7039 quartz grey Quarzgrau	Sales price excl. VAT UVP zzgl. MwSt.
35	27	90	36	9.4	A 19969	19968	20591	20659	395.-
50	42	90	36	11.9	B 19971	19970	20592	20660	479.-
35	27	125	36	11.4	C 19973	19972	20593	20661	459.-
50	42	125	36	15.5	D 19975	19974	20594	20662	565.-

See first chapter page for color options and detailed material characteristics!
Farboptionen und ausführliche Materialeigenschaften siehe erste Kapitelseite!



PANDORA





See first chapter page for color options and detailed material characteristics!
Farboptionen und ausführliche Materialeigenschaften siehe erste Kapitelseite!



Ø	Ø	□	□	kg	white Weiß	black Schwarz	RAL 7016 anthracite grey Anthrazitgrau	RAL 7039 quartz grey Quarzgrau	Sales price excl. VAT UVP zzgl. MwSt.
40	22.5	32	26	2.1	A 19966	20613	20589	20657	250,-
60	33	45	40	5.0	B 19967	20614	20590	20658	459,-

inliner: Make planting easier

er.



inliner: Erleichtern das Bepflanz Bepflanzen.

PURCHASING NET PRICES / NETTO-EINKAUFSPREISE

#	ROUND / RUND			1 pc. basic price	2-9 pcs. save 15%	10-49 pcs. save 25%	> 50 pcs. save 35%	> 500 pcs. save even more
	Ø	□	☒					
17893	15	15	11	2,20	1,87	1,65	1,43	BEST PRICE!
17894	21	16	16	2,80	2,38	2,10	1,82	BEST PRICE!
17895	25	15	18	3,30	2,81	2,48	2,15	BEST PRICE!
17896	30	22	21	4,70	4,00	3,53	3,06	BEST PRICE!
17897	35	25	24	4,95	4,21	3,71	3,22	BEST PRICE!
18603	40	30	28	5,95	5,06	4,46	3,87	BEST PRICE!
18604	45	35	32	7,10	6,04	5,33	4,62	on demand auf Anfrage
18605	50	38	36	8,90	7,57	6,68	5,79	BEST PRICE!
18606	55	40	43	11,50	9,78	8,63	7,48	BEST PRICE!
18607	60	45	44	12,50	10,63	9,38	8,13	BEST PRICE!
18608	65	48	53	13,80	11,73	10,35	8,97	BEST PRICE!
18609	70	45	54	19,50	16,58	14,63	12,68	BEST PRICE!
18610	80	60	70	25,00	21,25	18,75	16,25	BEST PRICE!



#	LEAN / SCHLANK			1 pc. basic price	2-9 pcs. save 15%	10-49 pcs. save 25%	> 50 pcs. save 35%	> 500 pcs. save even more
	Ø	□	☒					
19799	25	21	16	3,50	2,98	2,63	2,28	BEST PRICE!
18614	35	40	26	8,20	6,97	6,15	5,33	on demand auf Anfrage
18615	40	45	30	10,50	8,93	7,88	6,83	BEST PRICE!

#	SQUARE / ECKIG			1 pc. basic price	2-9 pcs. save 15%	10-49 pcs. save 25%	> 50 pcs. save 35%	> 500 pcs. save even more
	□	☒	☒					
18611	32x32	30	27	5,90	5,02	4,43	3,84	BEST PRICE!
18612	38x38	30	35	7,60	6,46	5,70	4,94	on demand auf Anfrage
18613	48x48	35	42	11,50	9,78	8,63	7,48	BEST PRICE!

Prices on this page are **purchasing net prices**, not recommended sales prices as on the other pages.
 Preisangaben auf dieser Seite sind **Netto-Einkaufspreise**. Keine UVPs wie auf den übrigen Seiten.

The inliner are ideally suitable to line all kinds of pots, e.g. terracotta, ceramics, stainless steel or wood. They make pots leak proof and replace unappealing coasters. A time-consuming and unsafe sealing with silicone or pond liner is not necessary any more. The liner is made of soft and flexible plastic which can be cut or bent as needed. They also

prevent calcium deposits on planters surfaces and cause less evaporation and watering.

Perfekt geeignet zur Auskleidung von allen Pflanzgefäßen, z. B. Terrakotta, Keramik, Edelstahl, Holz. Sie machen jedes Gefäß auslaufsicher und ersetzen optisch unschöne

Unter-setzer. Dank der Pflanzeinsätze entfällt zeitaufwändiges und unsicheres Abdichten mit Teichfolie oder Silikon. Da sie aus weichem, biegbarem Kunststoff hergestellt sind, passen sie sich flexibel an das Gefäß an und lassen sich individuell beschneiden. Zudem werden Kalkablagerungen an den Gefäßwänden vermieden und die Verdunstung reduziert.

INLINER



Also fits in rectangular planters
 Passen auch in eckige Pflanzgefäße



Adjust the height
 Höhe anpassen



Perfect fitting
 Passt perfekt

Perfect to smoothly adjust the planting depth of columns or tall planters
 Optimal zum Ausgleich von Pflanztiefen bei Säulen oder hohen Gefäßen

inliner advantages

- Makes all pots leak proof
- Can be cut or bent as needed
- Even adapts to square shapes
- Smoothly adjusts planting depth of planters
- Prevents calcium deposits
- Causes less evaporation and watering

The display has a large sign showing the application range and advantages and guarantees an optimal product presentation. Thanks to its modular construction it offers versatile display possibilities. The display is suitable for indoor and outdoor use and saves valuable space in the sales area. Because it is preassembled on euro pallets, the display is easy to handle with a forklift or pallet jack. It also includes a brochure rack and space for price tags on each bracket.

Der Verkaufsständer ist ausgestattet mit einem großflächigen Schild, auf dem Anwendungsbereich und Vorteile der Pflanzeinsätze aufgezeigt werden - damit ist eine optimale Produktpräsentation gewährleistet. Durch den modularen Aufbau ist er individuell bestückbar. Der Verkaufsständer ist sowohl im Innen- als auch Außenbereich einsetzbar und spart wertvollen Raum im Verkaufsbereich. Zudem ist er auf Europaletten vormontiert und daher leicht mit Gabelstapler oder Hubwagen zu transportieren. Inklusive Prospekthalter und Vorrichtung für Preisschilder an jedem Korb.



FREE/ GRATIS DISPLAY

for orders of 300 pieces of inliners/ bei Abnahme von 300 Stück

INLINER (VERKAUFSSTÄNDER · DISPLAY)		sales price excl. VAT UVP zzgl. MwSt.
kg	#	
14,5	16018	398,-



ROCKS



Real rocks, slate and glass from nature - every piece is unique. Illustrations exemplary. Packed in transparent bags.

Echte Steine, Schiefer und Glas aus der Natur - jedes Stück ein Unikat. Abbildungen beispielhaft. In transparenten Beuteln.



SLATE · SCHIEFER

Ø	kg	slate schiefer	sales price excl. VAT UVP zzgl. MwSt.
2-4	5	22279	15,-
4-7	5	22280	15,-



COCONUT SHELL · KOKOSSCHALE

Ø	kg	black schwarz	sales price excl. VAT UVP zzgl. MwSt.
0,3-0,4	5	28689	49,-



RIVER PEBBLES · FLUSSKIESEL

Ø	kg	white weiß	sales price excl. VAT UVP zzgl. MwSt.
2-4	5	19847	25,-
2-4	20	19850	85,-



NATURAL STONES · NATURSTEINE

Ø	kg	grey hellgrau	sales price excl. VAT UVP zzgl. MwSt.
0,16-0,22	5	28690	25,-
0,16-0,22	25	28691	105,-



RIVER PEBBLES · FLUSSKIESEL

Ø	kg	black schwarz	sales price excl. VAT UVP zzgl. MwSt.
2-4	5	19849	25,-
2-4	20	19852	85,-

Small things for the perfect look

Kleinigkeiten für den perfekten Look.

The styrofoam inserts smoothly adjust the planting depth - especially for tall planters - and save time and material.

Die Styroporeinsätze sind ideal geeignet zum Anpassen der Pflanztiefe - besonders bei hohen Gefäßen - und sparen Zeit und Material.

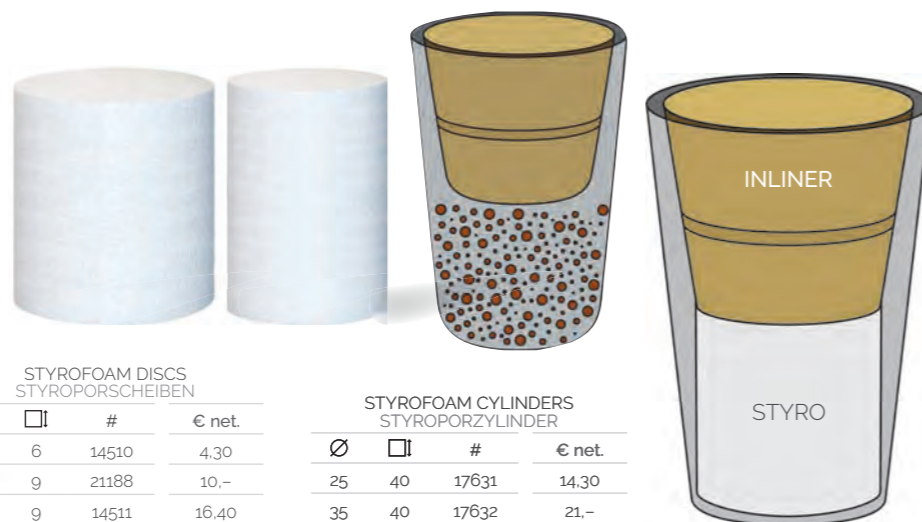

STYROFOAM DISCS STYROPORSCHLEIBEN			
Ø	□	#	€ net.
37	6	14510	4,30
45	9	21188	10,-
60	9	14511	16,40

STYROFOAM CYLINDERS STYROPORZYLINDER			
Ø	□	#	€ net.
25	40	17631	14,30
35	40	17632	21,-

CLAY · TON

The clay convinces with a very good water retention and capillarity. It has a stable structure, is purely mineral and therefore supports the gas exchange from substrate to the root perfectly. The clay is ideal for hydroculture and roof planting, frost and weather resistant and does not rot or compress. Further grain sizes and packing sizes are available on request (e. g. bags, big bags or bulk). The minimum order unit for expanded clay is 1 pallet ex works and

1 bag (Lamstedt-Ton only) ex warehouse Tönisvorst. Please ask our sales team for pricing.

Der Ton überzeugt mit einer sehr guten Wasseraufnahmefähigkeit und -führung. Zudem ist er strukturstabil, rein mineralisch und fördert daher den Gasaustausch von Substrat und Wurzel. Dank seines günstigen Dränierverhaltens beugt er Wurzelfäulnis vor und ist ideal für Hydrokulturen und Dach-

begrünungen. Darüber hinaus ist der Ton frost- und witterungsbeständig und verrottet und verdichtet nicht. Weitere Körnungen und Gebindegrößen sind auf Anfrage erhältlich (z. B. auch Big Bags oder lose Ware). Blähton ist palettenweise ab Werk erhältlich. Lamstedt-Ton alternativ auch sackweise ab Lager Tönisvorst. Bitte erfragen Sie die jeweiligen Preise bei unserem Vertriebsteam.

BIG BAG Gebinde auf Anfrage/on request

LAMSTEDT-TON®				sales price excl. VAT UVP zzgl. MwSt.
Ø mm	ltr	#	#	
8-16	50	36	14520	34,-





Healthy growth

Gesundes Wachstum.

Especially invented for hydroponic use, the long term fertiliser is based on ion exchange resin and provides plants with essential nutrients and trace elements. It seeps directly to the roots and the time release components ensure effectiveness for 4 to 6 months. Thanks to dry resin the volume remains constant - therefore there is no volume loss during storage. The long term fertiliser is available in various packaging sizes; from small consumer packs up to bulks for professionals. The labels are multilingual and also available with your own private label upon request.

Der speziell für Hydrokulturen entwickelte Ionenaustauscher versorgt die Pflanzen mit wichtigen Nährstoffen und Spurenelementen. Er rieselt direkt bis zur Wurzel und wirkt dort gleichmäßig über 4-6 Monate. Durch trockene Harzkügelchen hält er sein Volumen konstant und schrumpft auch bei längerer Lagerung nicht. Von Portionsverpackungen für Endverbraucher bis zu Großbinden für Profis - der Langzeitdünger ist in diversen Verpackungsgrößen lieferbar. Die Etikettierung ist mehrsprachig und auf Anfrage auch mit eigenem Etikett möglich.

HM10™ LONG TERM FERTILIZER · LANGZEITDÜNGER

Type	#	€ net.
10 ltr	10247	295,-
25 ltr	10249	695,-



LEAFSHINE BLATTGLANZ

LEAFSHINE includes natural oils for a healthy shine and makes sure that water and calcium stains disappear for good. Moreover, the leaves remain dust-free for an extended period. LEAFSHINE also helps to protect against insects and prevents excessive evaporation. The ready-to-use solution is environmentally safe propellant (CFC free). For canisters a hand sprayer with 15 m hose length is available.

LEAFSHINE enthält pflanzliche Öle für einen gesunden, natürlichen Glanz und verhindert dauerhaft eine Bildung von Wasser- und Kalkflecken. Zudem sorgt es dafür, dass die Blätter lange Zeit staubfrei bleiben und schützt die Pflanze vor übermäßiger Verdunstung. Das verwendete Treibmittel ist umweltfreundlich, da FCKW-frei und das LEAFSHINE ist sprühfertig und unverdünnt anwendbar. Für Kanisterware ist ein Handsprüher mit einem 1,5 m langem Schlauch optional erhältlich.

LEAFSHINE BLATTGLANZ

Type	☞	☞	#	Sprachen · Languages	€ net.
750 ml	12	960	10104	DE, NL, UK, FR, ES, IT, Arabic	13,-

LEAFSHINE is also available in various large containers.

LEAFSHINE ist auch in verschiedenen Großbinden erhältlich.



LEAFSHINE · BLATTGLANZ FASS

Type	#	Sprachen · Languages	€ net.
200 ltr	10102	DE, UK, FR, ES	1999,-





SPART ZEIT UND AUFWAND

Das SERVICE CAR ist besonders leicht und robust dank des innovativen Fiberglastanks. Für mehr Wendigkeit und Übersichtlichkeit sorgt das Gestell mit seinen vergleichsweise kleinen Abmessungen. Für ein einfaches Verladen und Transportieren ist das SERVICE CAR mit kleinen Rollen am Griff ausgestattet. Leise, kugelgelagerte Rollen mit innenliegenden Radmuttern (damit Sie schadensfrei durch die Räume Ihres Kunden kommen) garantieren ein dezentes und geräuscharmes Arbeiten vor Ort. Dazu kommen weitere tolle Vorteile: Das SERVICE CAR wird in drei verschiedenen Größen angeboten (bis zu 140 Liter Füllvolumen) und es garantiert bis zu 80% Zeitersparnis, da es automatisch ohne Aufsicht befüllt werden kann und wartungsfrei ist, da es ohne Strom, Motor und Kabel auskommt. Wahlweise werden Geka- oder Gardena-Anschlüsse mitgeliefert. So sorgt das SERVICE CAR für einen professionellen Auftritt beim Kunden und ein körperschonendes, bequemes Arbeiten. Einfach, sicher, sauber!



More information online!

THE ULTIMATE TIME SAVER

Thanks to its innovative fibreglass tank the SERVICE CAR is extremely light and robust and its smaller frame guarantees better handling. For easy loading and transport the handles have small wheels. For a damage-free plant maintenance at your customer's premises, the SERVICE CAR has silent, ball bearing wheels with short wheel nuts. It is available in three different sizes up to 140 litres of water volume. The SERVICE CAR enables up to 80% time savings, because it automatically fills without supervision and is maintenance-free, because it works without any electricity, cable or motor. Furthermore you can choose between Geka or Gardena

connections. The SERVICE CAR provides a professional appearance and promotes a comfortable and healthy working environment. Easy, safe and clean!

SERVICE CAR			
Type	ltr	kg	#
GARDENA Mod. L	70	34	20683
GARDENA Mod. XL	100	47	20684
GARDENA Mod. XXL	140	53	20685
GEKA Mod. L	70	34	20686
GEKA Mod. XL	100	47	20687
GEKA Mod. XXL	140	53	20688

*depending on water pressure / abhängig vom Wasserdruck

PRICES · PREISE

Prices and delivery time on demand
Preise und Lieferzeiten auf Anfrage

ACCESSORIES · SERVICE CAR ZUBEHÖR

Type	#
Utility bag · Zubehörtsche	14404
GARDENA spray gun · Spritzpistole	15617
GARDENA watering lance · Gießlanze	15616
GARDENA fertiliser injector · Dünginjektor	14414
GEKA fertiliser injector · Dünginjektor	15967
GEKA watering lance · Gießlanze	15968



Utility bag with waterproof plastic container
Zubehörtsche mit wasserdichtem Kunststoffbehälter



Water spray gun
Spritzpistole



Watering lance
Gießlanze



Fertiliser injector
Dünginjektor mit Zubehör

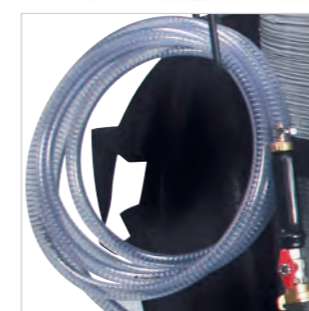

Sturdy PVC fabric hose (5 m)
Robuster PVC Spiralschlauch (5 m)



Light coloured, silent wheels
Helle, leise Rollen



Emergency stop valve
Sicherheits-Absperrhahn



Parking brake
Feststellbremse



GEKA connector
GEKA Adapter



GARDENA connector
GARDENA Adapter



Handle with small loading wheels
Griff mit kleinen Verladerrollen



Easy loading by one person possible
Einladen durch eine Person möglich

PREMIUM ARTIFICIAL PLANTS

decopoint®

decopoint gmbh,
Mathilde Beyerknecht Str. 14
3100 St. Pölten
Austria

Mail: service@decopoint.at
Tel: +43 2742 23124
Fax: +43 2742 258025

webshop: www.decopoint.eu
facebook: [facebook.com/decopoint.eu](https://www.facebook.com/decopoint.eu)
Youtube: [youtube.com/decopointgmbh](https://www.youtube.com/decopointgmbh)

NEW!
Artificial
Plants

<https://www.decopoint.at/Kunstpflanzen>

2024 | 2025